

AXILE
agile smart machining



G8 SERIES

**GANTRY TYPE 5-AXIS VERTICAL
MACHINING CENTER**



WE ARE AXILE

AXILE designs and builds agile smart 5-axis VMCs with leading automation solutions for manufacturers of complex parts and components.

“ We believe manufacturers shouldn’t have to choose between high-speed and high-performance 5-axis machines. ”

By combining sheer agility, digitalized intelligent automation, and a new standard of 5-axis machining, we’ve created an all-new approach:

Agile Smart Machining.

In short, our dedicated team of industry experts brings together ultra-high removal rates, pinpoint precision, and 24/7 automation and reliability within each and every AXILE 5-axis machine.

Our breakthrough design concepts and advanced proprietary technologies serve highly sophisticated manufacturers of complex parts and components for applications in aerospace, die and mold, medical, and general job shop, among others.

The AXILE service and support network spans nearly 50 countries, with more than 70 distributors across Asia, Europe, and the Americas, and a service center in Croatia.



CONTENTS

4 G8 GANTRY TYPE VMC

DESIGN CONCEPT

AGILITY

ACCURACY

SPINDLE

CHIP MANAGEMENT

TOOL MANAGEMENT

ERGONOMICS

CONTROL UNIT

MILL-TURN

16 STANDARD & OPTIONAL EQUIPMENT

18 TECHNOLOGIES

ART™ - INTELLIGENT MONITORING SYSTEM

SMT™ - SMART MACHINING TECHNOLOGY

21 LAYOUT AND WORKSPACE

22 TECHNICAL DATA

G8 GANTRY TYPE VMC

The AXILE G8's powerful gantry design perfectly balances rigidity and precision, ideal for the machining of complex workpieces.

With a maximum loading capacity up to 1,300 kg on a swiveling, rotary table, complemented by high-performance built-in spindles, the G8's agility enables production of a wide range of large parts and tools.

The G8 MT option offers both milling and turning in one machine, greatly increasing operational flexibility. By reducing set-up times and potential clamping errors, the G8 MT can efficiently machine a wider variety of parts, including cylindrical components.



DESIGN CONCEPT

THE STRUCTURE

1

Spindle moved by 3 linear axes

No rotary axis between the tool and the machine body, for better machining rigidity.

4

Massive gantry sliding on 2 symmetric synchronized axes

Best servo response to any milling forces

2

Perfect U-shape closed gantry design

Same stability in all travels of X and Y axes
Excellent accessibility to working area

5

All body made of high-quality casting

Homogeneous thermal behaviour
Optimal damping of machining vibrations

3

Table moved by swivelling rotary axes

Best accuracy with fixed relative position between 2 rotary axes

6

Integrated chip disposal channel directly under the table

Quick evacuation of chips for high chip volume machining

7

3-guided headstock

Highest rigidity in roughing processes with high torque in spindle

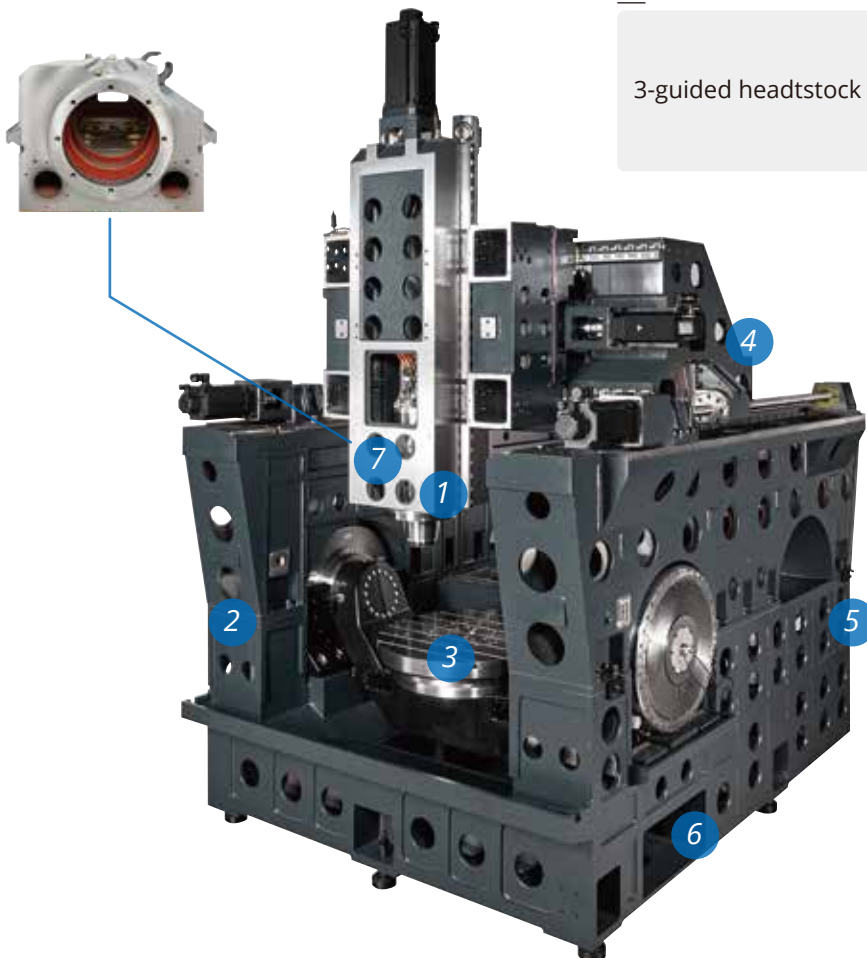

AGILITY

LINEAR AXES

1

Direct driven servo motors (no belts/gears)

Best dynamic and minimal elasticity in the driving system

2

Double symmetric and synchronized axes (Y1, Y2)

Best dynamic for the gantry no matter the position of the machining force

Linear scales with 0,1 μm resolution in X, Y1, Y2 and Z axes

Ensures optimal synchronization in Y1 and Y2 axes, and best accuracy for ALL axes

Double roller type linear guideways

Best high-feed movement and vibration damping

Double pre-loaded double-nut ballscrews

Minimized backlash allowing high-feed movements

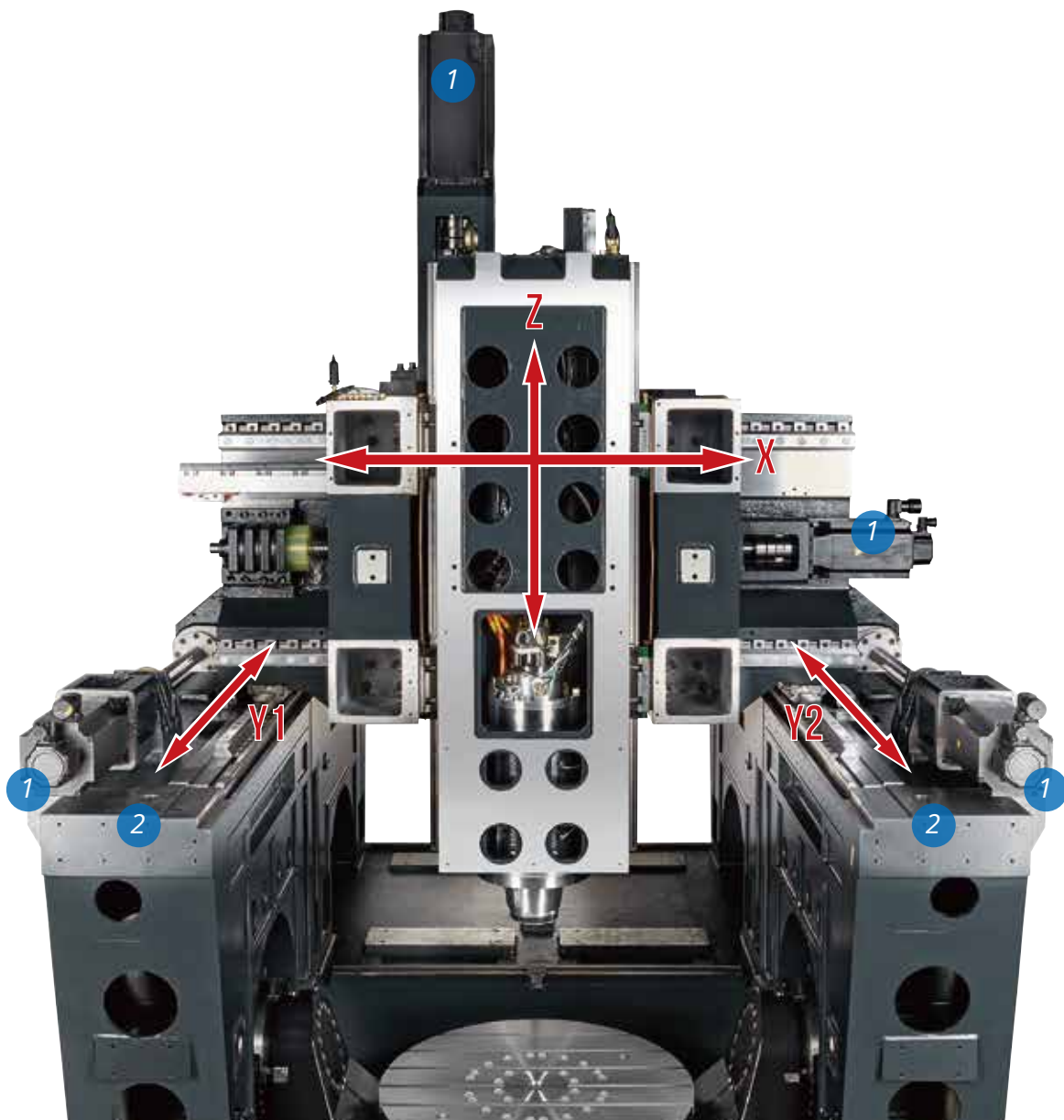

SWIVELLING-ROTARY AXES

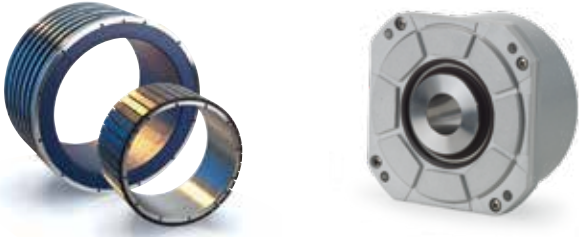

1

Integrated and ready-to-use hydraulic and pneumatic ports	Simplifying parts clamping process
---	------------------------------------

2

Torque motor-driven rotary axis (C)	Highest dynamics
Dual torque motor-driven swivelling axis (A)	Highest accuracy
Brakes in every shaft	High-repeatability in 5-axis operation when using the brakes
High-resolution, direct absolute rotary measuring system	Zero-backlash and high accuracy

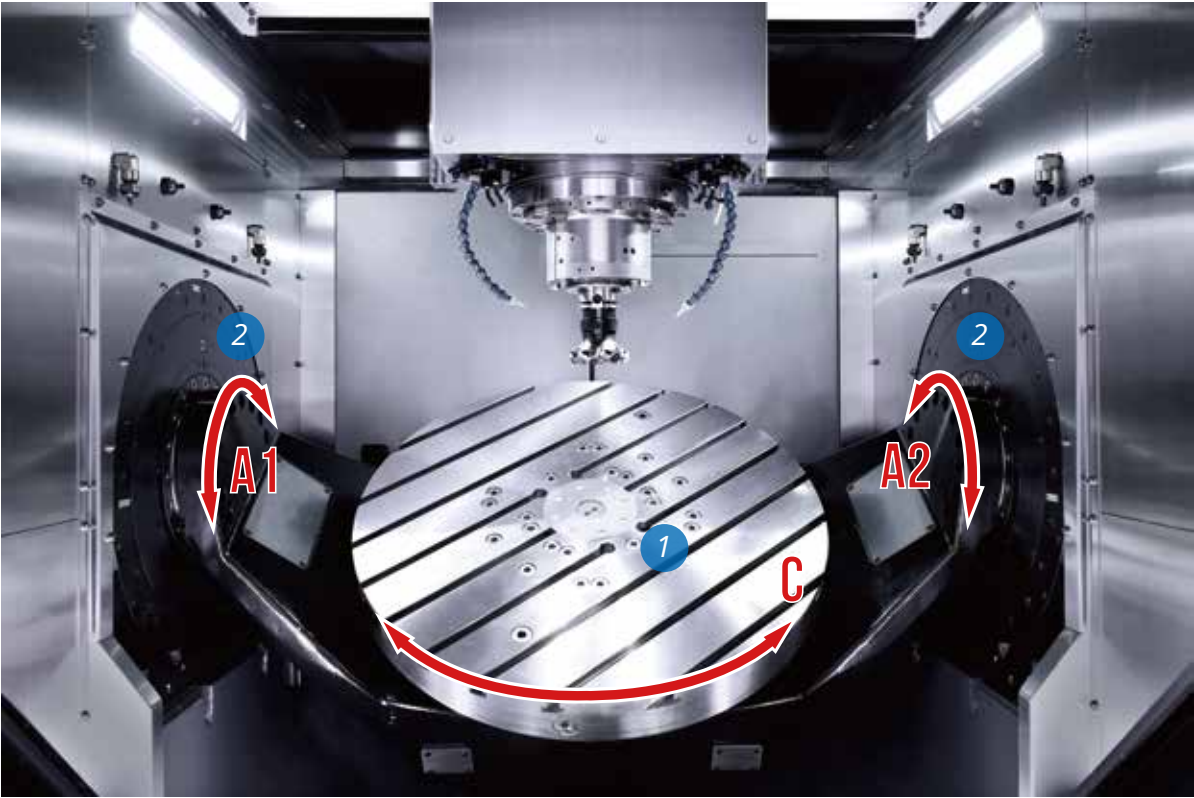

ACCURACY

THE CORNERSTONE OF 5-AXIS MACHINING

Linear axes accuracy

Ballscrew's thermal growth

0.1 μ m resolution absolute linear scales in ALL axes



Rotary axes accuracy

Elasticity and backlash of driving system

Direct-driven torque motors with no backlash

Angular error is multiplied by the distance from rotary axis to machining point

+/- 5" accuracy absolute rotary scale feedback



Thermal control

Heat generated by spindle and torque motors

Spindle and torque motors are cooled with a water chiller $\pm 0.2^\circ$ close-circuit and a cooling unit



Linear-rotary axes relative positioning

The swivelling-rotary table might shift its relative position to the 3 linear axes by many reasons generating an increasing error in the part

CNC embedded compensating functions like Kinematics (Heidenhain), Kinematic chain (Siemens) and Tilted working plane indexing (Fanuc)



SPINDLE

HIGH-PERFORMANCE BUILT-IN SPINDLE SELECTION



Spindle A

- > 15.000 rpm
- > HSK A63
- > 130/200 Nm S1/S6-40%
- > 30/46 kW S1/S6-40%

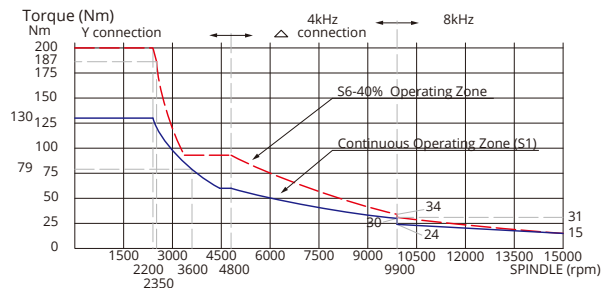
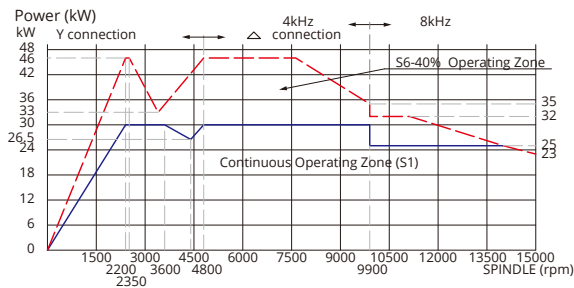

- > Double coil asynchronous motor

- > 20.000 rpm
- > HSK A63
- > 87/135 Nm S1/S6-40%
- > 25/40 kW S1/S6-40%

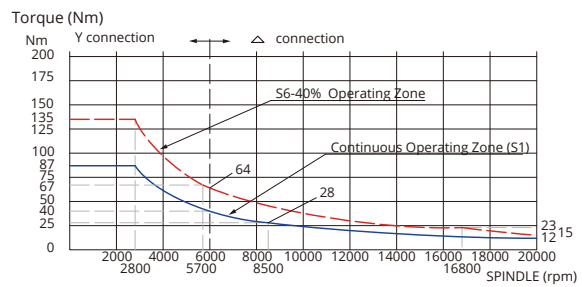
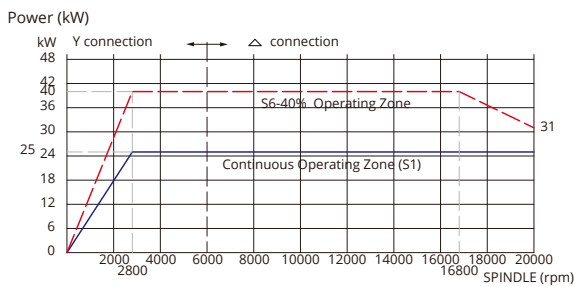

- > Double coil asynchronous motor

Spindle B

- > 15.000 rpm
- > HSK A63
- > 120/160 Nm S1/S6-40%
- > 25/33 kW S1/S6-40%

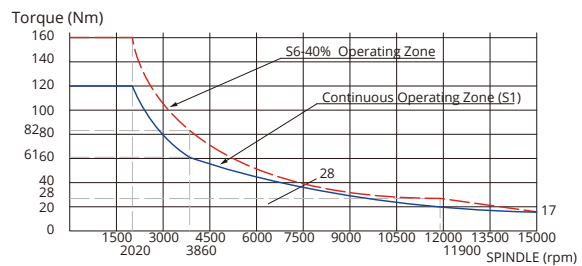
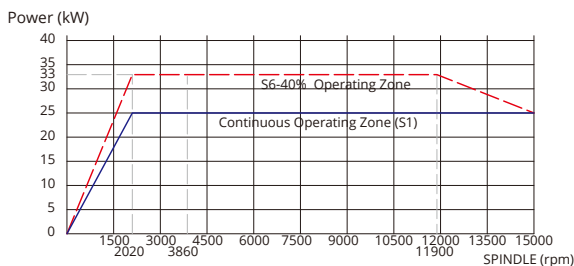

- > Double coil asynchronous motor

- > 20.000 rpm
- > HSK A63
- > 77/120 Nm S1/S6-40%
- > 23/36 kW S1/S6-40%

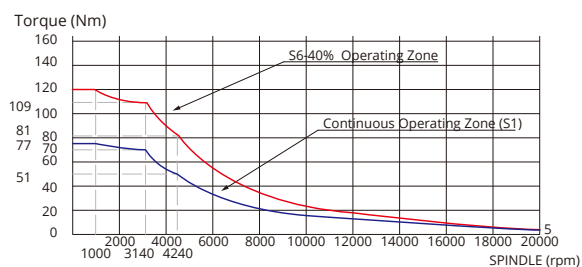
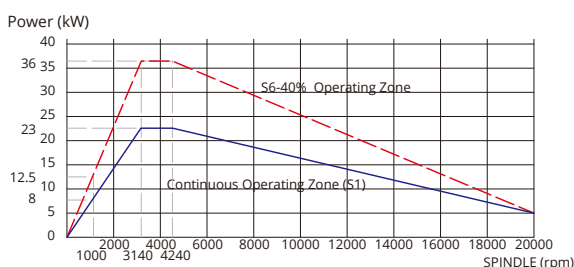

- > Double coil asynchronous motor

CHIP MANAGEMENT

FLUSHING CHIPS AWAY



High-quality stainless steel working area

Long-lasting clean operation

Sharp walls and no-corner design

Easier to flush away chips by shower

2 x led lights spindle nose

For optimal illumination of the tool cutting

- 1 Coolant through spindle
- 2 4x coolant at spindle nose
- 3 2x led lights
- 4 Coolant flushing
- 5 Air flushing
- 6 Chip wash down
- 7 Chip conveyor



TOOL MANAGEMENT

FLEXIBLE CAPACITY FOR EVERY APPLICATION

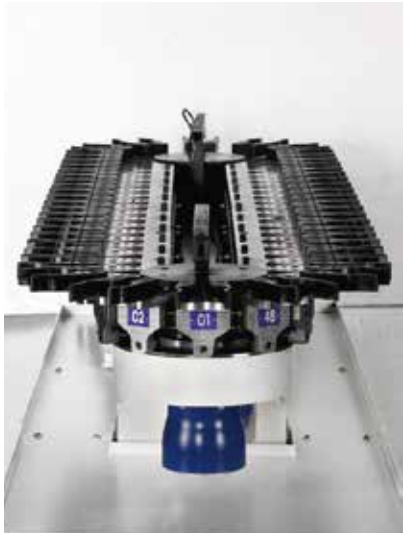

Single or twin carrousel of 32, 48 or 60 tools can be selected and capacity doubled to 64, 96 or 120 tools. Up to 96 tools machine layout is not modified.

Sister tools, complex parts and unmanned operation can be executed with no worries on the tool magazine capacity.

Carrousel-type magazine with 32 to 120 tools capacity

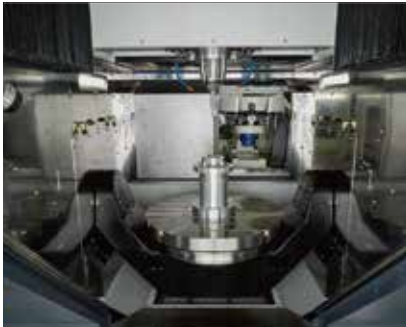
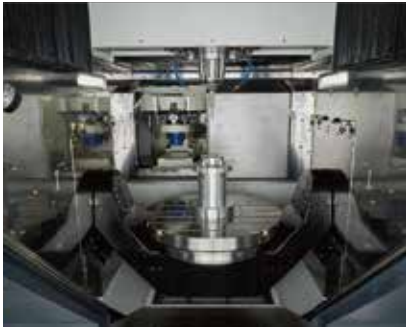
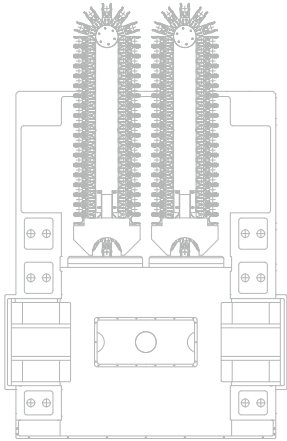
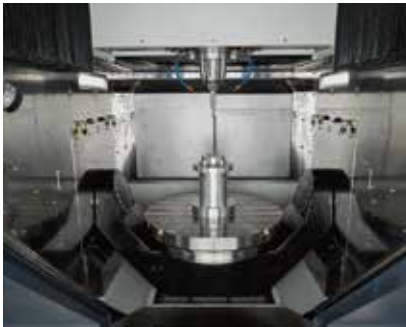

ERGONOMICS

ACCESSIBILITY TO WORKING AREA

Large front door opening	Comfortable access to working area for workpiece preparation and supervision
Short distance from operator to table	Ergonomic loading and unloading of small parts
Automatic roof to open ceiling working area	Easy loading and unloading of heavy and bulky workpieces by over-head crane



AUTOMATIC ROOF

For overhead crane loading and unloading

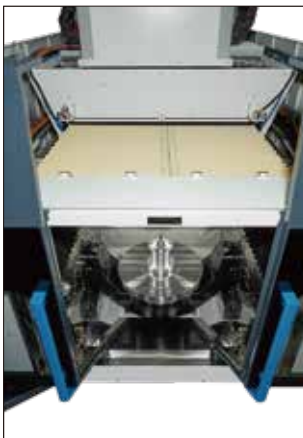

Roof closed



Automatic sliding of roof



Fold-up the roof



Easy access to table center

EASIER TOOLING MANAGEMENT AND MAINTENANCE

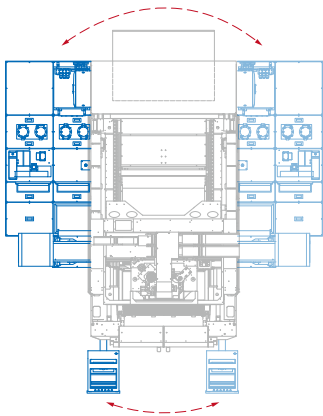

Tools are accessible from back of the machine and stored vertically.

Tools can be easily changed during automatic operation.

All necessary consumables are located together in the back of the machine.

Easier maintenance routine for operator.

Smart tool: interface panel is used to select the tool. When finished, the system checks whether all tool holders are in the right position.

Avoid human failures when automatically change tool to spindle, protecting spindle and reducing down-time.

The accessories and control panel can be customized in either sides of machine.

Optimized layout and ergonomic operation



CONTROL UNIT

A CONTROLLER FOR EVERY USER

Heidenhain TNC 640

- > Kinematics
- > Dynamic Collision Monitoring
- > Tool Center Point Management
- > Tilted the Working Plane

Heidenhain TNC 640

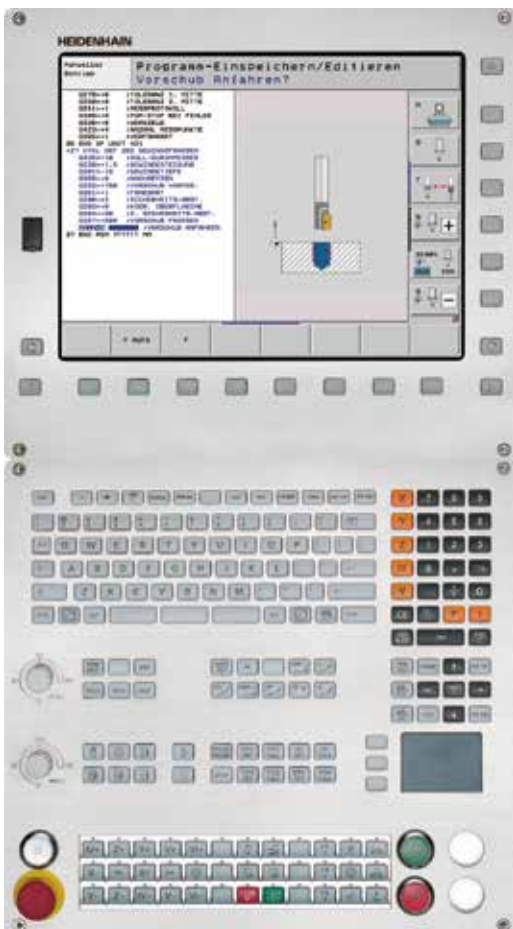

SINUMERIK ONE

- > Kinematics chain
- > Collision Avoidance
- > 5-axis transformation with tool orientation
- > Swivel the Coordinate System

Fanuc 31i-B5 plus

- > 3D Interference Check
- > High Speed Smooth TCP
- > Tilted Working Plane indexing

Sinumerik ONE



Fanuc 31i-B5 plus



MILL-TURN

The mill-turn function is for those who are looking for maximum integration of metal-cutting processes in a single step and to reduce the complex operations and minimize the clamping errors.



There is cooling system for the C-axis motor, inner and outer bearing of C-axis when in the turning function to ensure the accuracy and long-lasting life.

Table diameter: 800 mm, 31.5 in
Max turning speed: 1000 rpm
Max table load in turning: 850 kg, 1873 lbs
Max table load in milling: 1200 kg, 2645 lbs



For accurate tool measurement in length, radius and shape

For in-process tool measurement at working conditions (spindle running at thermal stable conditions)



Integrated balancing system that can be monitored from the additional screen located on top of the panel, with the help of a sensor located in the A-axis

STANDARD & OPTIONAL EQUIPMENT

Optimized design and well organized of electrical connectors and cables.

Easier maintenance

High-speed and twisting stress cycles



Major heat generating electrical components like transformer and line filters are kept in a separate cabinet for easier temperature control.

Electrical cabinet is maintained at stable temperature using an air conditioner



Optional Chain-type chip conveyor with chip bucket, oil skimmer and built-in 40 bar through spindle coolant pump are provided for selection.

They can be positioned either side of the machine for layout customization



Standard in G8 / Optional in G8 MT
Integrated and ready-to-use 3 hydraulic and 1 pneumatic port. Clamping and unclamping functions by softkeys in the control panel and/or by M-function.

Optional

- > Integrated and ready-to-use 8x hydraulic (80 bar) or pneumatic (6 bar) ports
- > 4x vacuum port

Simplifies 5X workpiece clamping.

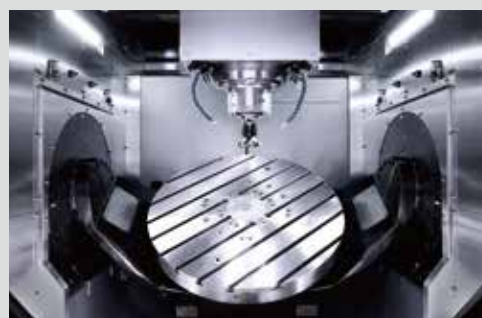

Automatic workpiece measurement (with probe, receiver and reference ball)

Automatic compensation of the linear-rotary axis relative positioning:
Kinematics (Heidenhain), Kinematic chain (Siemens) and Tilted working plane indexing (Fanuc)

For accurate workpiece positioning or in-process measuring of some machining features.



U-type embedded in the table (for highest accuracy).
Laser tool measurement.



Spin window

For easier view of working area when huge amount of coolant and chips are produced



Separate type CTS unit including:

- > Cartridge filter
- > Paper filter
- > Through spindle 40 & 70 bar centrifugal and screw pumps
- > Oil skimmer
- > Oil cooler

Recommended for high aluminum or cast iron material



Chip conveyor

Chain type conveyor takes bigger and curly chip away. Scraper type conveyor takes smaller and lighter chips as well as dusty chips away.

TECHNOLOGIES

ART™

INTELLIGENT MONITORING SYSTEM

The future of manufacturing depends on optimized intelligent production. To gain an edge on the competition, embracing smart manufacturing is the best way to stay ahead of the curve. To deliver agile smart machining, and that all-important competitive edge, we have created ART™, an intelligent monitoring system that enables 24/7 operations and eliminates unexpected downtime. ART™ monitors all wearing components, energy consumption, and fluids such as lubricant and coolant, to supply real-time status updates on the machine and its components, and to pre-empt future issues.

Utilizing ART™ in daily operations immediately improves production efficiency by empowering machinists to make informed decisions. Moreover, ART™ gives manufacturers the reassurance required to embrace automation solutions, by delivering vital oversight through total operational transparency.

ART™ framework

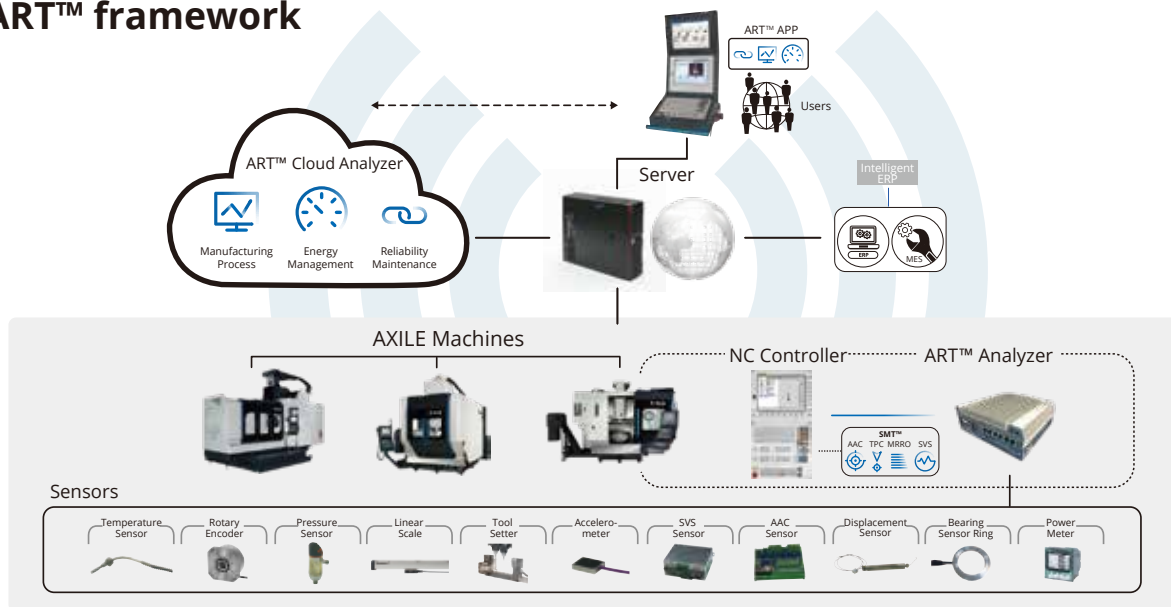

The Core Functions to Boost Productivity & Profitability

Manufacturing Process (MP)

Unexpected downtime is the enemy of profitability. ART™ delivers machine components diagnosis, machine lifetime estimation, and consumable supplies monitoring to prevent machine failure and eliminate unplanned downtime.

Reliability Maintenance (RM)

Knowledge is power. ART™ achieves superior data collection and analytics on machine status and utilization rates, to deliver real-time information for optimized production strategies.

Energy Management (EM)

Every penny counts. ART™ enables manufacturers to monitor their power consumption, to identify ways to maximize energy efficiency and reduce expenditure.

Intelligent Management (IM)

ART™ provides analytic information for managers to understand the machine performance and take the immediate actions to optimize the machine capability.

Industry 4.0 Solutions to Intelligent Machine

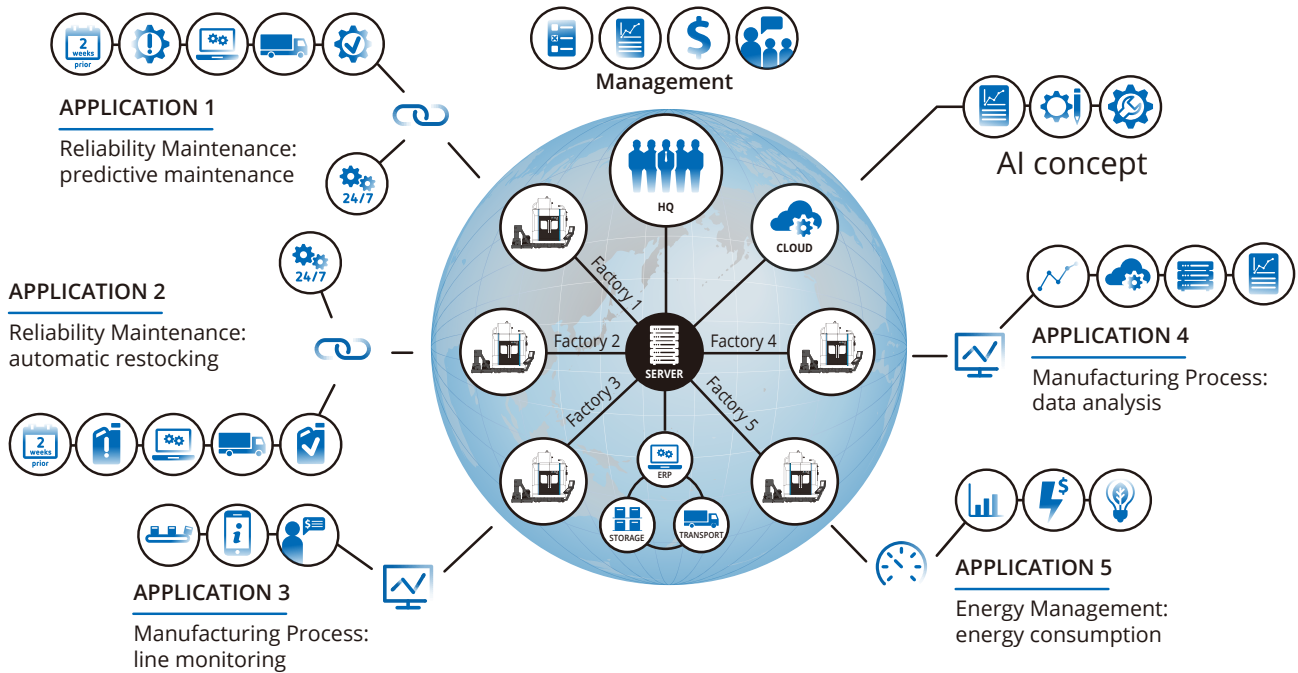

How ART™ Brings Production Benefits

- > Clearly displays machine status, for quick decision-making
- > Maximizes machine accessibility and utilization, for optimized production
- > Provides real-time notification of abnormal conditions, for swift intervention
- > Gives machinists the information required to optimize removal rates and machine lifetime

How ART™ Brings Maintenance & Service Benefits

- > Delivers pre-emptive error messages prior to breakdown, to eliminate unexpected downtime
- > Decreases service expenses, by precisely identifying the issue
- > Enhances service efficiency, by recommending appropriate action
- > Reduces spare parts inventory, by highlighting exactly what is needed and when
- > Automatically orders new parts, by linking to online purchasing system
- > Allows machines and equipment to remain on stand-by, always ready to work

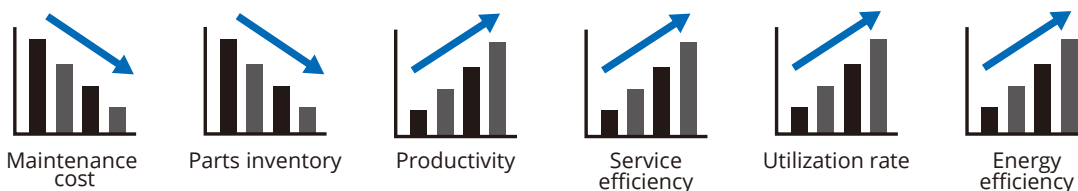

SMART MACHINING TECHNOLOGY

As pioneers of advanced mechatronic systems with decades of R&D expertise, AXILE has taken 5-axis CNC machining to the next level. Our patented SMT™ (Smart Machining Technology) delivers groundbreaking compensation and calibration functionality for unrivaled cutting speeds and industry-leading accuracy, and more importantly, resolves the aforementioned issues created by thermal expansion.

With AXILE's SMT™ manufacturers can have it all. There's no longer the need to choose between speed and precision, meaning manufacturers can produce superior parts rapidly, while also securing total process reliability and long-term machining performance.



Axial Accuracy Control



- > **AXIAL THERMO MONITORING**
Integration of temperature sensors and thermal error model
- > **HIGH PRECISION**
Thermal induced positioning error compensation

Thermal Error Before and After Compensation

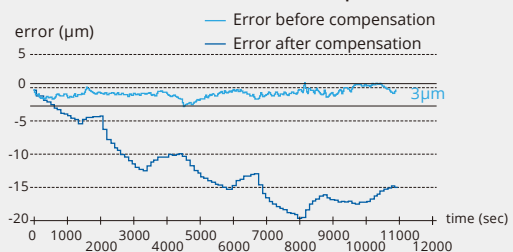

With thermal compensation system, the thermal error can be reduced from 20µm to 3µm.



Tool-tip Positioning Control



- > **HIGH ACCURACY**
Directly measuring expansion
- > **BETTER SURFACE FINISH**
5~6 times accuracy improved
- > **REAL-TIME COMPENSATION**
Electrical type sensor

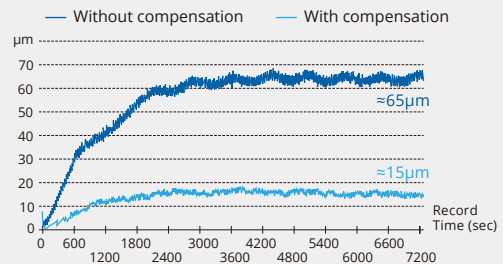

With compensation, the displacement of tool tip is reduced from 65µm to 15µm.

ACCURACY IMPROVED 5~6 TIMES!



Spindle Vibration Supervision

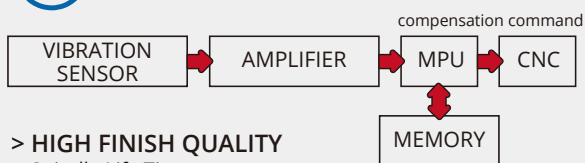

- > **HIGH FINISH QUALITY**
Spindle Life Time
- > **LONGER LIFE TIME**
Wear reduction on spindle bearings and tools
- > **EASY FOR MAINTENANCE**
Up to 12000 abnormal vibration data recording

Three Levels for Spindle Vibration Monitoring

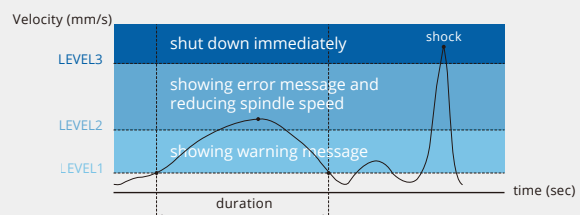

LAYOUT AND WORKSPACE

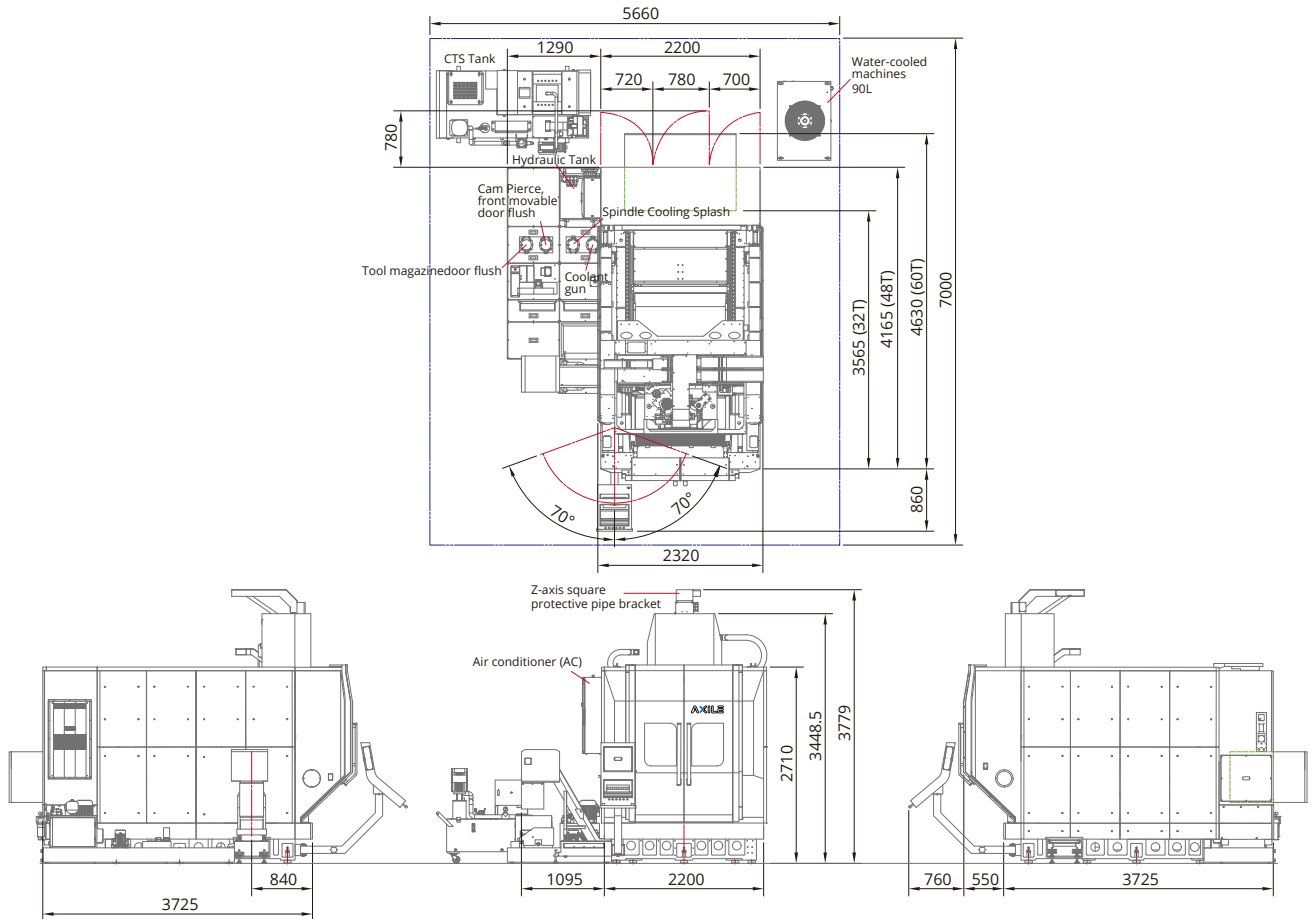

INTERFERENCE

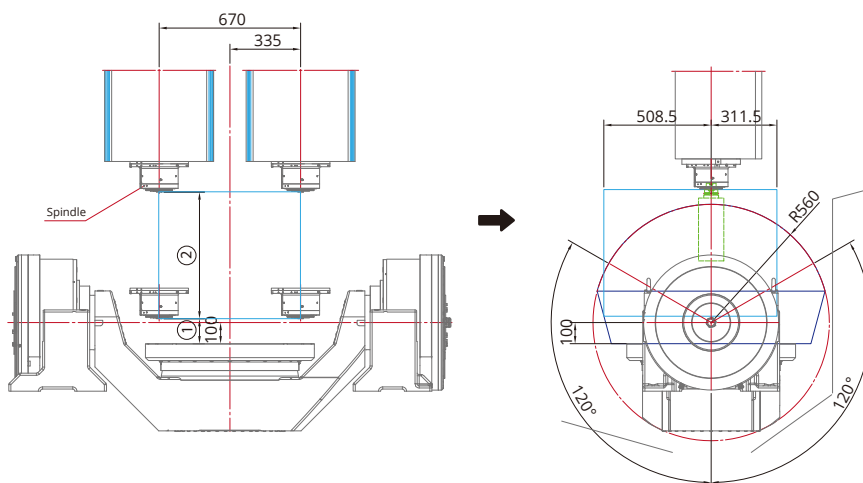

Spindle	①	②
A	130	600
B	146	600
Direct BT40	112	600
Direct BT50	110	550

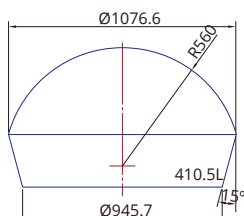

*Note:

The workpiece size for turning is limited by the weight (850 kg), its maximum height and the cutting force applied. Please request for the limitation diagram or send the drawing of the part to confirm if it can be machined.

TECHNICAL DATA

COMMON DATA FOR G8

TABLE (NOTE 1)			
Table size (diameter)	Ø800 mm	Ø31.5 in	
Number and hydraulic ports	3		
Working pressure of hydraulic ports	80 bar	1160.3 psi	
Number and pneumatic ports	1		
Working pressure of pneumatic ports	6 bar	87 psi	
LINEAR AXES			
X travel (carriage left and right)	670 mm	26.4 in	
Y travel (gantry back and forth)	820 mm	32.3 in	
Z travel (head stock up and down)	600 mm	23.6 in	
Max feedrate X/Y/Z	60 m/min	2362 in/min	
Guideways type	Roller		
Guideways size X/Y/Z	55/45/45 mm	2.1/1.7/1.7 in	
Distance between X/Y guides	590/1472 mm	23.2/57.9 in	
Ballscrew diameter/pitch	45/20 mm	1.7/0.7 in	
X/Y/Z axis motor power/torque	X/Y 6/19.2 ; Z 8.9/28.4 kW/Nm	X/Y 8/14.1 ; Z 11.9/20.9 hp/ Ft/lbs	
ROTARY AXES (NOTE 1)			
A range (swivelling)	±120 deg		
C range (rotary)	360 deg		
SPINDLE (STANDARD)			
Spindle speed	20000 rpm		
Transmission	Built-in		
Motor type	Asynchronous		
Bearing type (front/rear)	Angular ball		
Bearing cooling and lubrication	Oil/Air		
Power S1/S6-40%	A: 25/40 kW	B: 23/36 kW	A: 33/53 hp B: 30.8/48.3 hp
Torque S1/S6-40%	A: 87/135 Nm	B: 77/120 Nm	A: 64.2/99.5 Ft/lbs B: 56.8/88.5 Ft/lbs
SPINDLE (OPTIONAL)			
Spindle speed	15000 rpm		
Transmission	Built-in		
Motor type	Asynchronous		
Bearing type (front/rear)	Angular ball		
Bearing cooling and lubrication	Oil/Air		
Power S1/S6-40%	A: 30/46 kW	B: 30/46 kW	A: 40/61 hp B: 33.5/44.3 hp
Torque S1/S6-40%	A: 130/200 Nm	B: 130/200 Nm	A: 95.9/147.5 Ft/lbs B: 88.5/118 Ft/lbs
MEASURING FEEDBACK			
Linear axes type	Linear scale		
Linear axes resolution	0.1 µm		
Rotary axes type	Rotary scale		
Rotary axis accuracy	±5"		
TOOL CHANGER			
Change type	Pick-up		
Magazine type	Carrousel (x2)		
Carousel driving system	(x2) Servomotor and gearbox		
Magazine positions	32/64 48/96 60/120		
Tool shank type	HSK-A63		
Maximum tool length	300 mm	11.8 in	
Maximum tool diameter (with adjacent pot empty)	Ø75/Ø120 mm	Ø3/Ø4.7 in	
Maximum tool weight	7 kg	15.4 lbs	
Max. loading weight	160 kg/352.7 lbs (32T); 240 kg/529.1 lbs (48T); 300 kg/661.3 lbs (60T); 320 kg/705.4 lbs (64T); 480 kg/1058.1 lbs (96T); 600 kg/1322.7 lbs (120T)		
ACCURACY (VDI/D6Q 3441)			
Positioning	0.005 mm	0.0002 in	
Repeatability	±0.0025 mm	±0.00009 in	
EXTERNAL COOLANT SUPPLY			
External nozzels coolant supply (number) pressure	(4x) 3 bar	(4x) 43.5 psi	
External nozzels air supply (number) pressure	(2x) 6 bar	(2x) 87 psi	
Tank capacity	425 L	112.2 US gal	

COMMON DATA FOR G8 (CONT.)

SPINDLE THROUGH COOLANT SUPPLY (OPTIONAL)			
High pressure pump	40 bar	580.1 psi	
Filter type	Cartridge		
SPINDLE THROUGH COOLANT SUPPLY WITH SEPARATE TANK(OPTIONAL)			
High pressure pump	40/70 bar	580.1/1015.2 psi	
High pressure pump with stepless programable pressure	0-70 bar stepless	0-1015.2 psi stepless	
Filter type	Cartridge and paper band		
Additional accessory	Coolant chiller and oil skimmer		
CONTROL UNIT			
Brand/Model	Heidenhain TNC 640	Sinumerik ONE	Fanuc 31i-B5 plus
SUPPLIES			
Installed power	85 kVA		
DIMENSION			
Length	3565 mm/140.3 in (32T/64T); 4165 mm/163.9 in (48T/96T); 4630 mm/182.2 in (60T/120T)		
Width	4410 mm	173.6 in	
Height	3779 mm	148.7 in	
Weight	18000 kg	39683 lbs	
Floor Space	3565x4410mm/140.3x173.6 in (32T/64T); 4165x4410 mm/ 163.9x173.6 in(48T/96T); 4630x4410 mm/182.2x173.6 in (60T/120T)		

SPECIFIC DATA FOR G8

WORKPIECE AND TABLE (NOTE 1)				
Maximum table load (note 2)	B: 1200 kg	A/C: 1300 kg	B: 2645 kg	A/C: 2866 kg
Pitch of T-slot	B/C: 90 mm	A: 100 mm	B/C: 3.5 mm	A: 3.9 mm
SPINDLE				
Spindle taper	HSK-A63			
Spindle nose to rotary table clamping surface	130~730 mm		5.1~28.7 in	
ROTARY AXES (NOTE 1)				
Maximum swivelling (A) speed (note 2)	80 rpm			
Maximum rotary (C) speed	100 rpm			
Driving system in swivelling (A) axis	Dual torque motor			
Driving system in rotary (C) axis	Torque motor			

SPECIFIC DATA FOR G8 MT

WORKPIECE AND TABLE (NOTE 1)		
Maximum table load	850(Turning) / 1200(Milling) kg	1873(Turning) / 2645(Milling) lbs
T-slot (w/pitch/no)	14 x 30 x 12 mm	0.5x1.2x0.5 in
SPINDLE		
Spindle taper	HSK-T63	
Spindle nose to rotary table clamping surface	130~730 mm	5.1~28.7 in
ROTARY AXES (NOTE 1)		
Maximum swivelling (A) speed	15(Turning) / 100(Milling) rpm	
Maximum rotary (C) speed	1000(Turning) / 100(Milling) rpm	
Driving system in swivelling (A) axis	Dual torque motor	
Driving system in rotary (C) axis	Torque motor	
Power & torque of swivelling (A) axis	20.4/1948x2 kW/Nm	27.3/1436.8x1.4 hp/ Ft/lbs
Power & torque of rotary (C) axis	55/525 kW/Nm	73.7/387.2 hp/ Ft/lbs
Brake type of swivelling (A) axis	Hydraulic clamping	
Braking torque of swivelling (A) axis	4000x2 Nm	2950.4x1.4 Ft/lbs
Brake type of rotary (C) axis	Hydraulic clamping	
Braking torque of rotary (C) axis	4000 Nm	2950.4 Ft/lbs

* Specifications are subject to change without notice.

* NOTE1: Rotary-tilting table details may differ depending on the table manufacturer.

* NOTE2: The tech data may vary according to different brands.



AXILE HEADQUARTERS

E info@axilemachine.com
W www.axilemachine.com

©2022 AXILE. All rights reserved.



AXILE AMERICA

E info@axileamerica.com
W www.axileamerica.com