

CNC-TURNING CENTRES

B620-M-SM-Y-YS

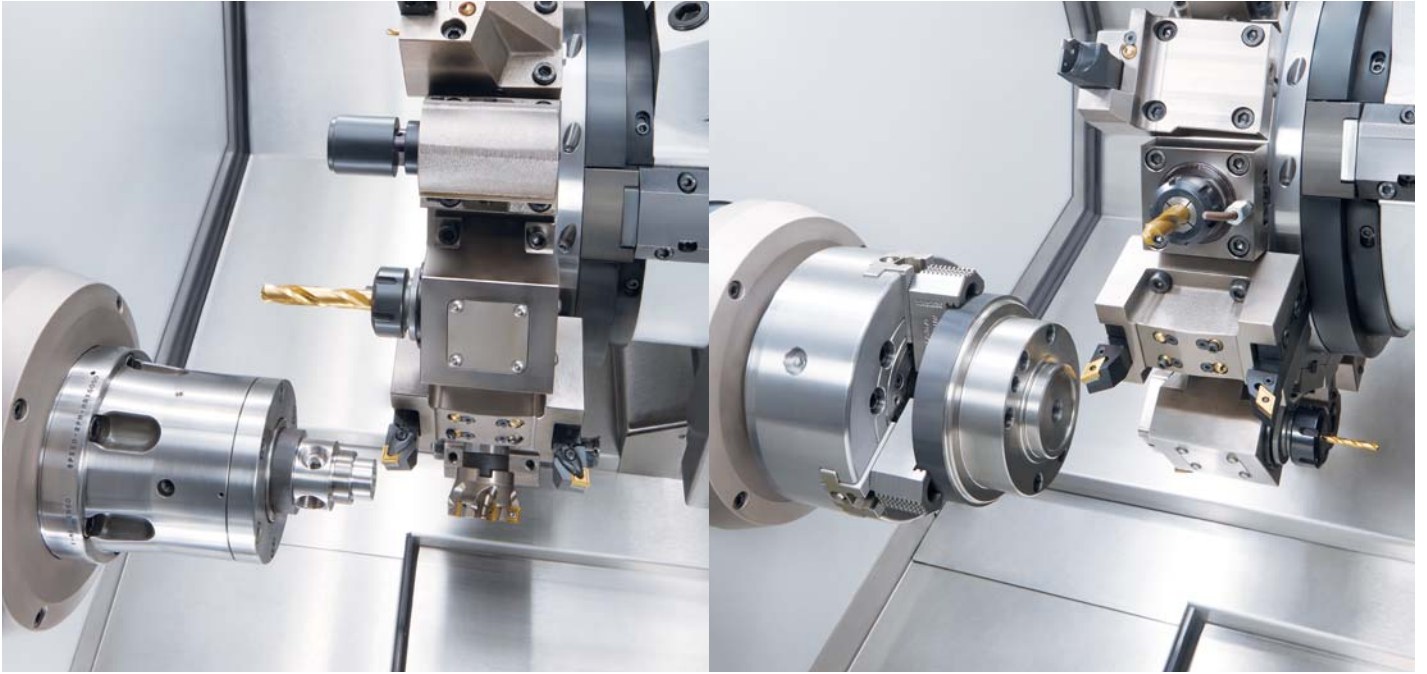

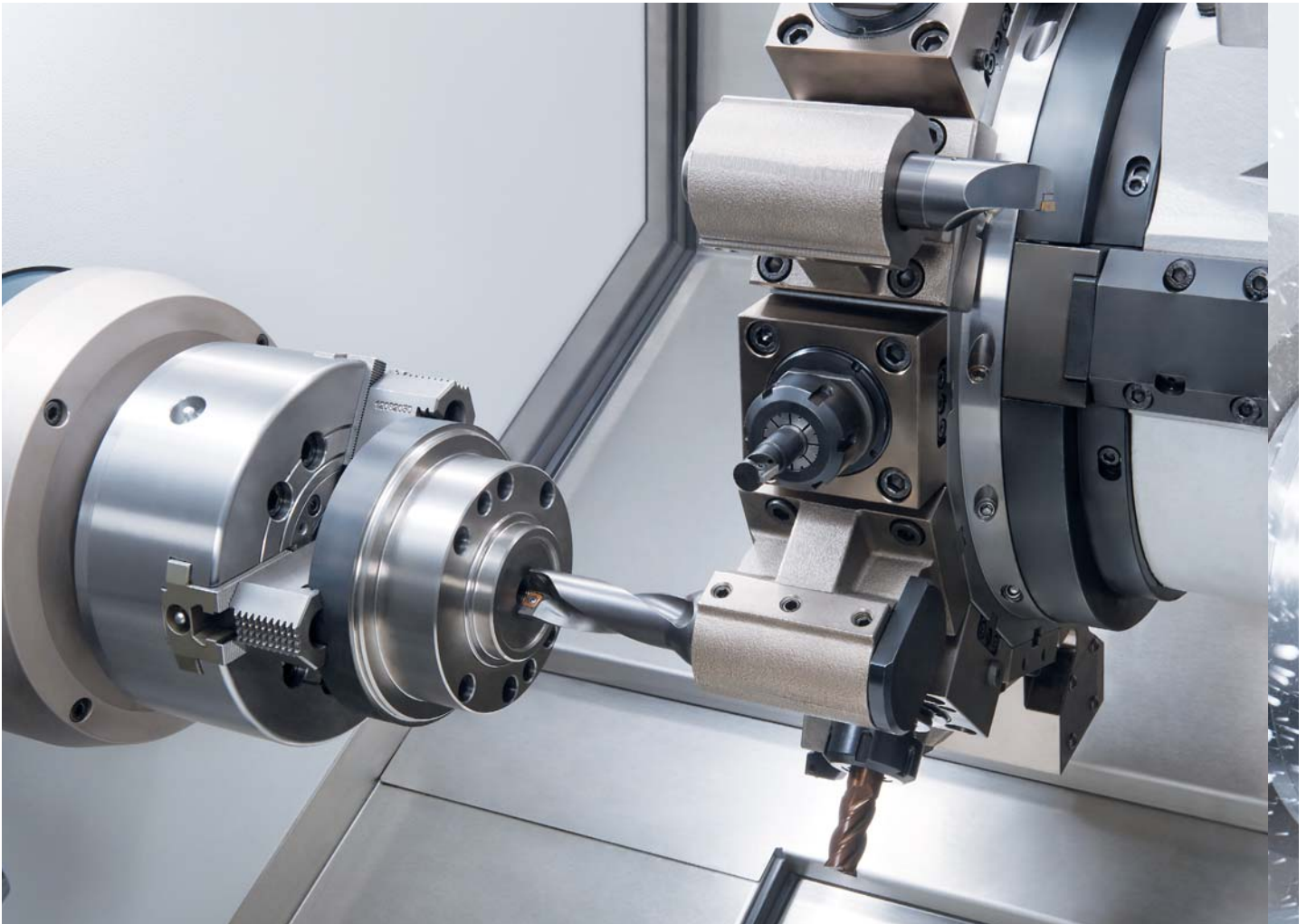

High-tech universal turning centre.

The new B620 represents the “state of the art” of multifunction turning centers. The modular concept and the high versatile options provide a wide spectrum of machining possibilities ranging from universal turning to complete machining of complex parts thanks to the CNC automatic tailstock, second spindle, rotary tools, spindle C-axis and Y-axis. The B620 is available in five versions with bar capacity of 51 or 70 mm.

STANDARD FEATURES

- Rigid cast-iron machine bed
- Powerful synchronous integral spindle motors
- 15 position Biglia servo turret
- CNC automatic tailstock
- Chip conveyor with coolant supply (medium pressure) including filter
- Synchronized sub-spindle and parts ejector
- Sub-spindle with B-axis load detection system
- Rigid tapping
- Bar-feeder interface
- Cooling system
- Two colour alarm lamp
- Electrical cabinet air conditioned
- Touch screen operator panel



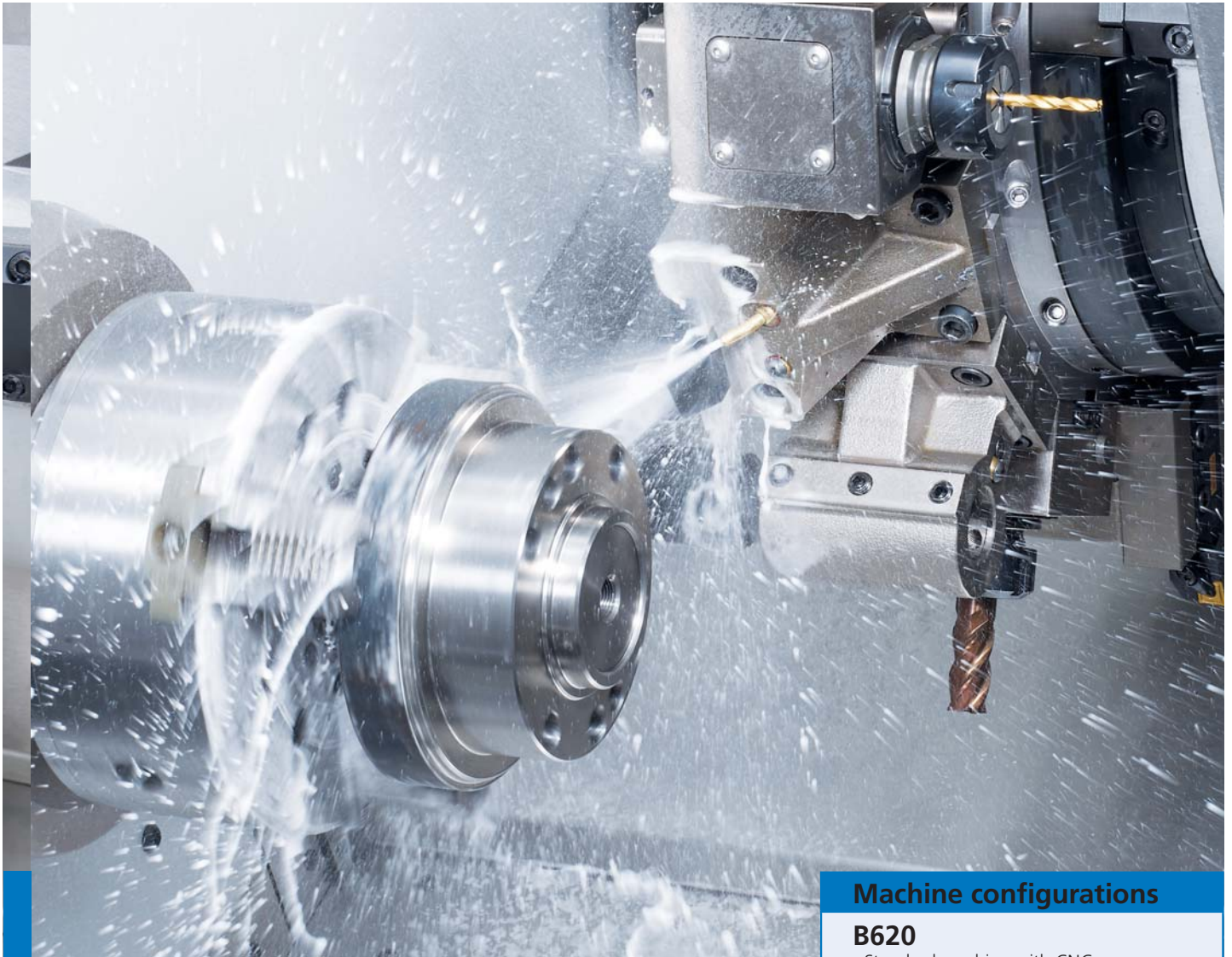

Machine configurations

B620

- Standard machine with CNC automatic tailstock

B620M

- Rotary tools (15)
- C-axis
- CNC automatic tailstock

B620SM

- Rotary tools (15)
- C-axis on the main spindle
- C-axis on the second spindle

B620Y

- Rotary tools (15)
- C-axis
- Y-axis
- CNC automatic tailstock

B620YS

- Rotary tools (15)
- C-axis on the main spindle
- Y-axis
- C-axis on the second spindle



DESIGNED TO ENSURE HIGH RIGIDITY AND ACCURACY

The new massive rigid cast-iron machine bed has been reinforced by 20% in comparison to the previous design. The roller guideways on the Z-axis and the "box type" guideways on the X and Y axes ensure high rigidity, speed and exceptional vibration dampening.

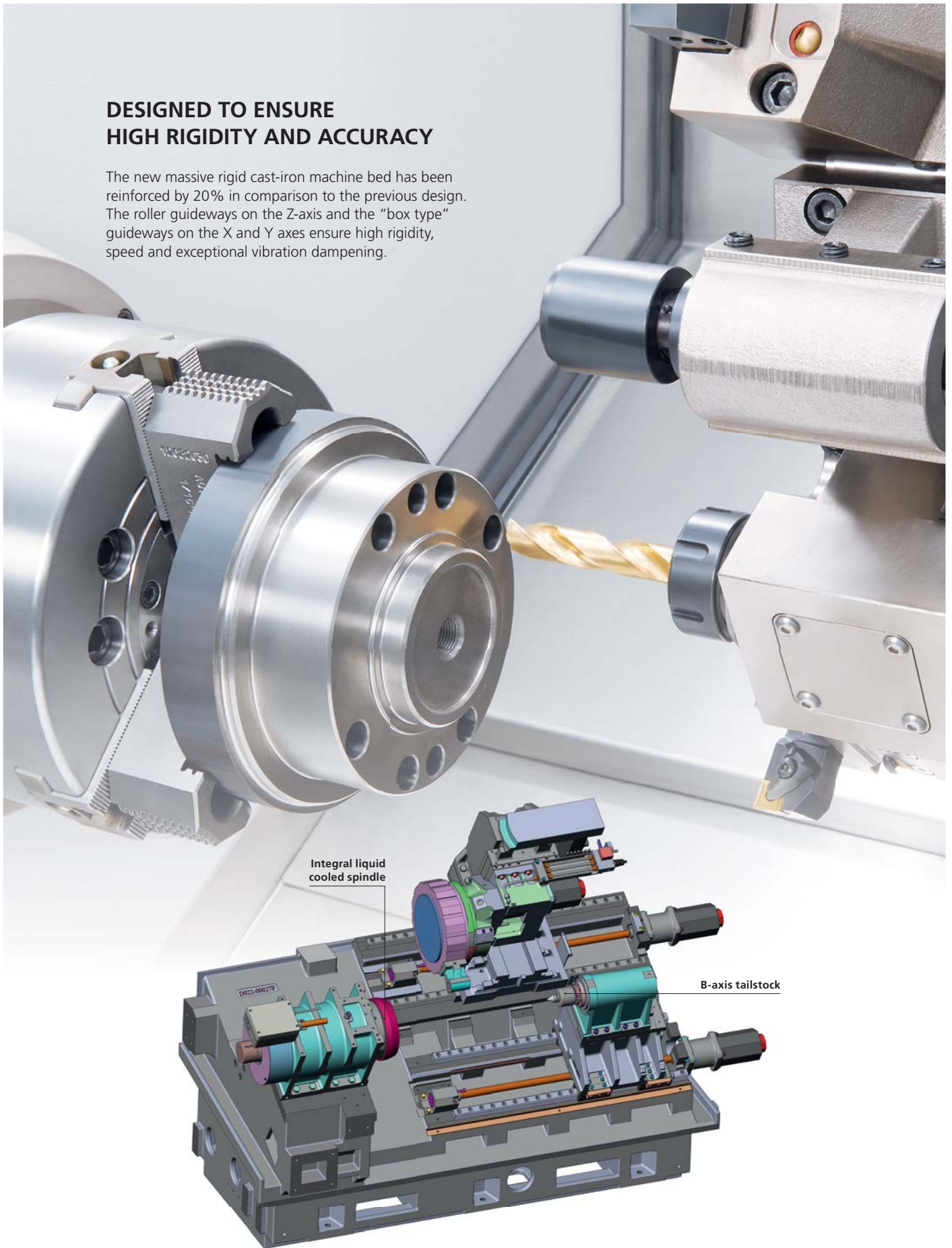

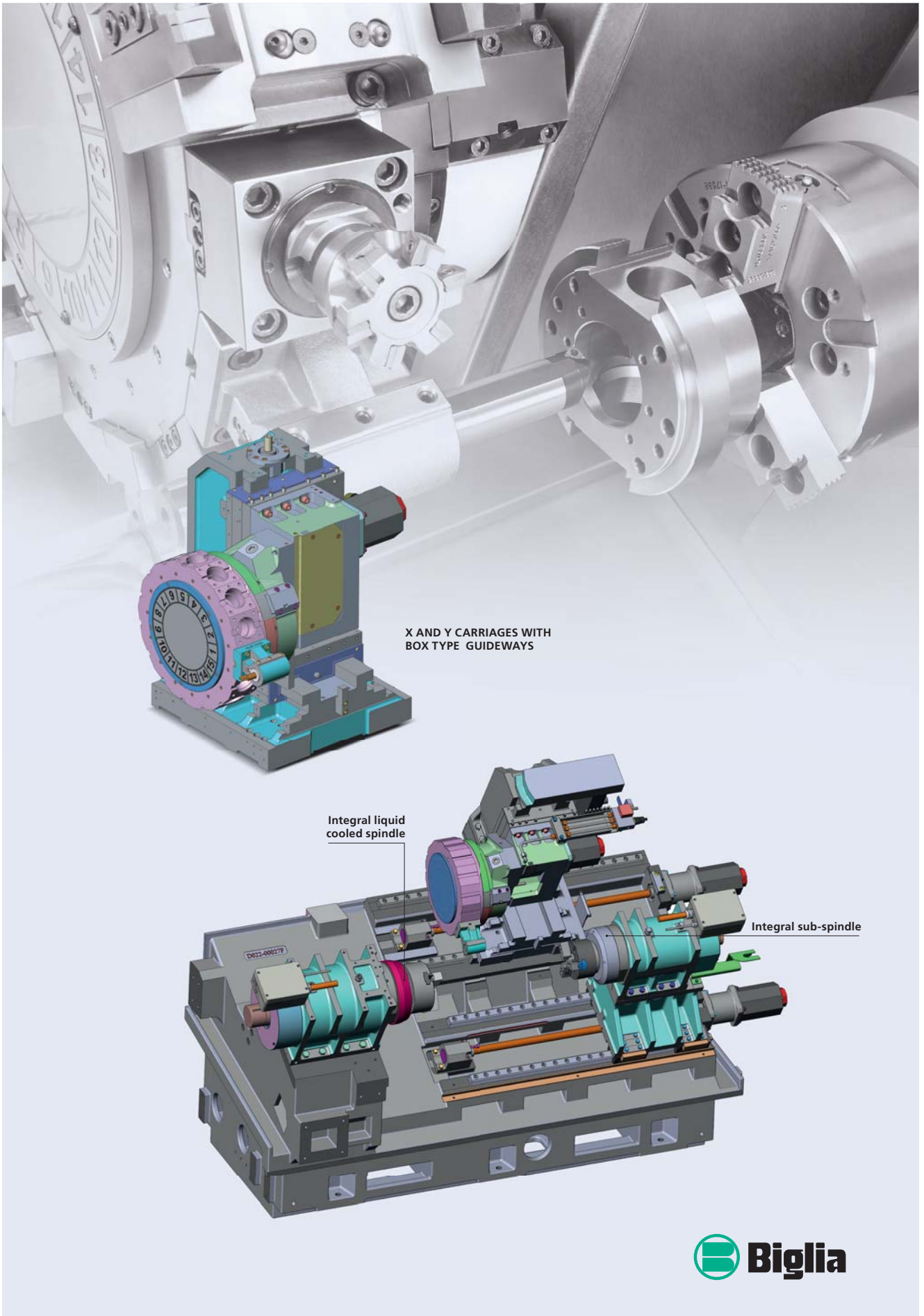

X AND Y CARRIAGES WITH BOX TYPE GUIDEWAYS

Integral liquid cooled spindle

Integral sub-spindle



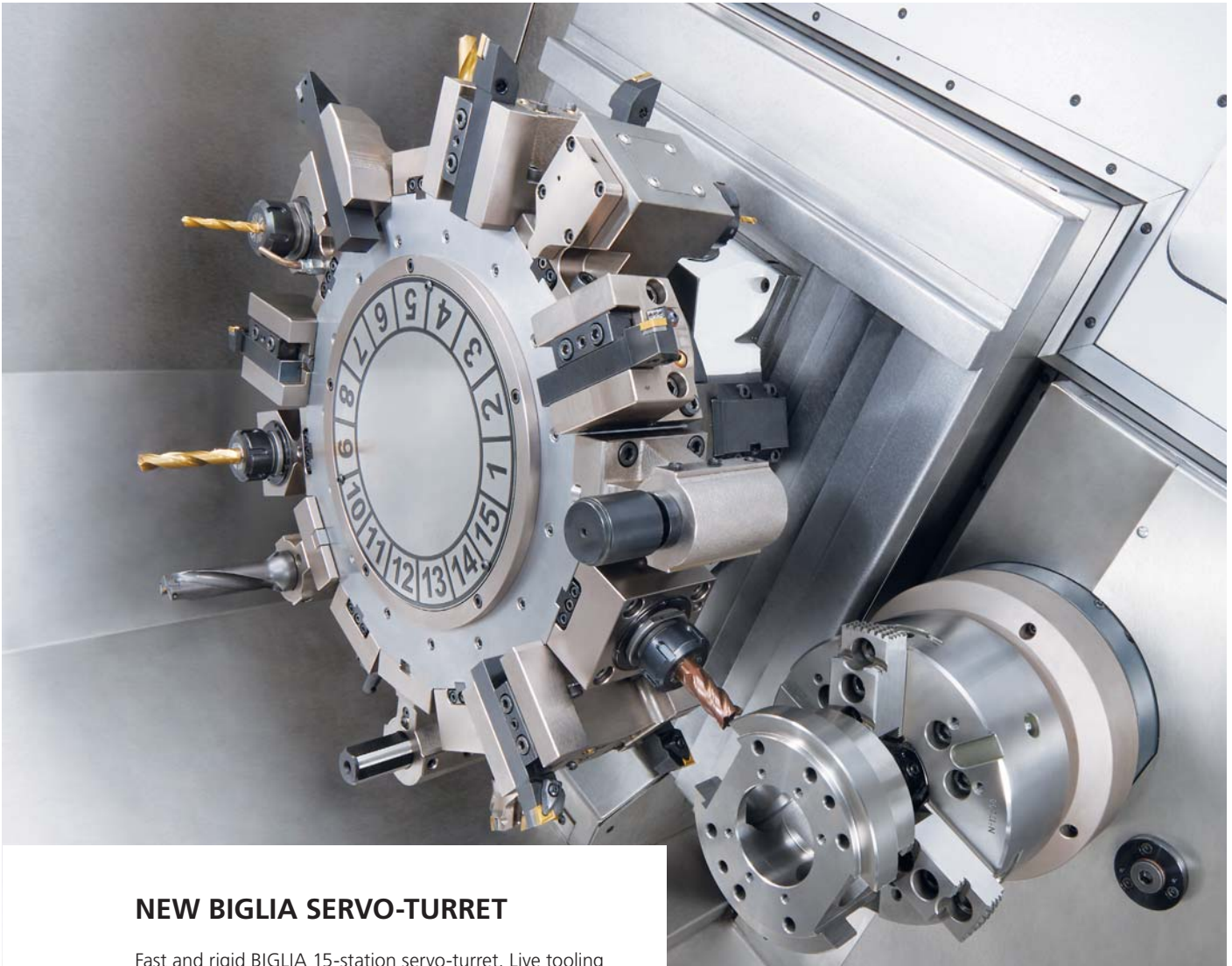

NEW BIGLIA SERVO-TURRET

Fast and rigid BIGLIA 15-station servo-turret. Live tooling on all positions. Up to 30 tools can be used together. The rotary tools are driven by a liquid cooled, synchronous built-in motor with 13 kW power and speed range of 6000 rpm. The rotary motion is transmitted by a built-in motor, lubricated and cooled by oil mist.

Live tools

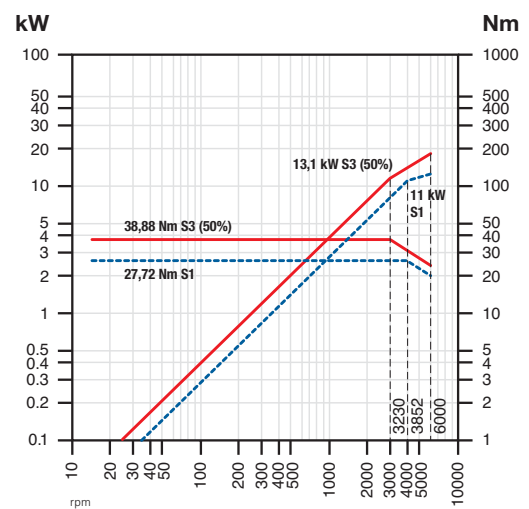
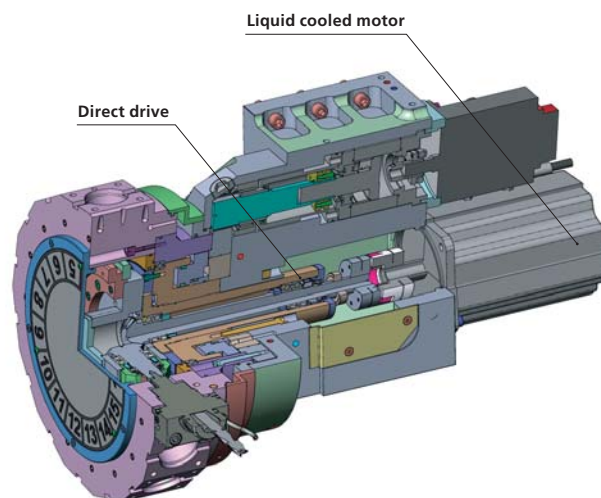

INTEGRAL MOTOR SPINDLES

The new liquid cooled integral motor spindles are driven by high-torque motors with unequalled power. They allow higher spindle speed. Also, the combination of the roller and ball bearings, plus the high torque and constant horsepower range, allow powerful cutting as well as exceptional finish and roundness accuracy.

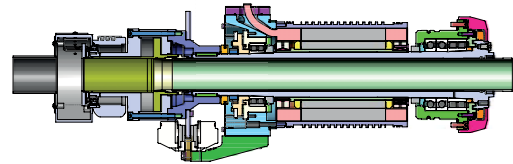
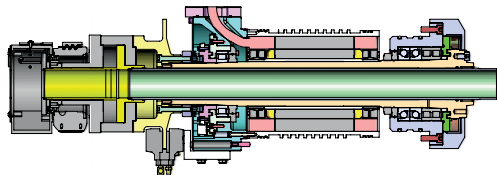
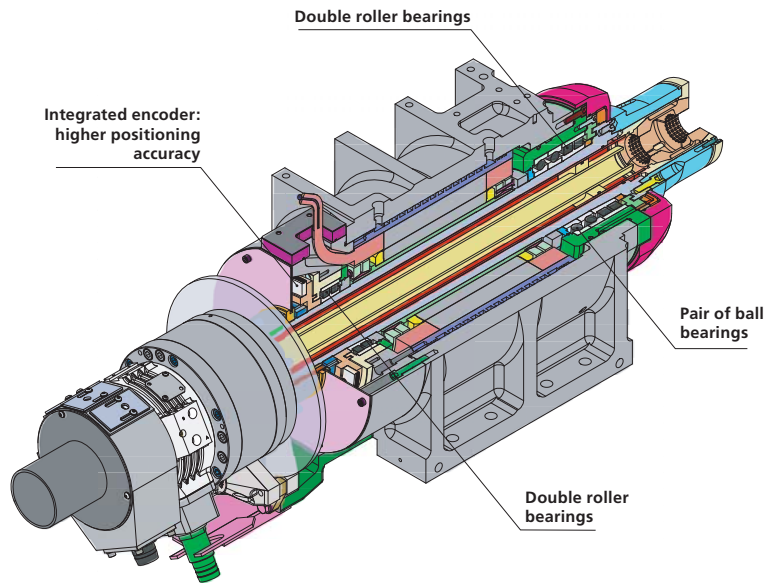

Main spindle - ASA 5" Sub-spindle

ASA 6" Main spindle

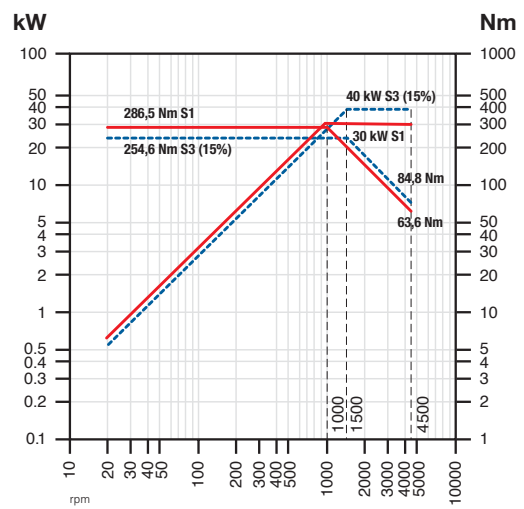
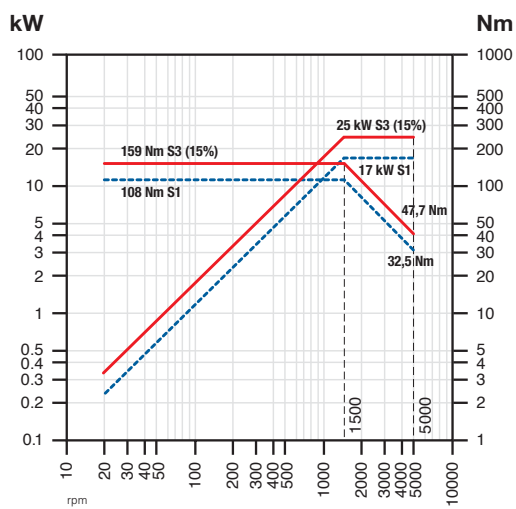

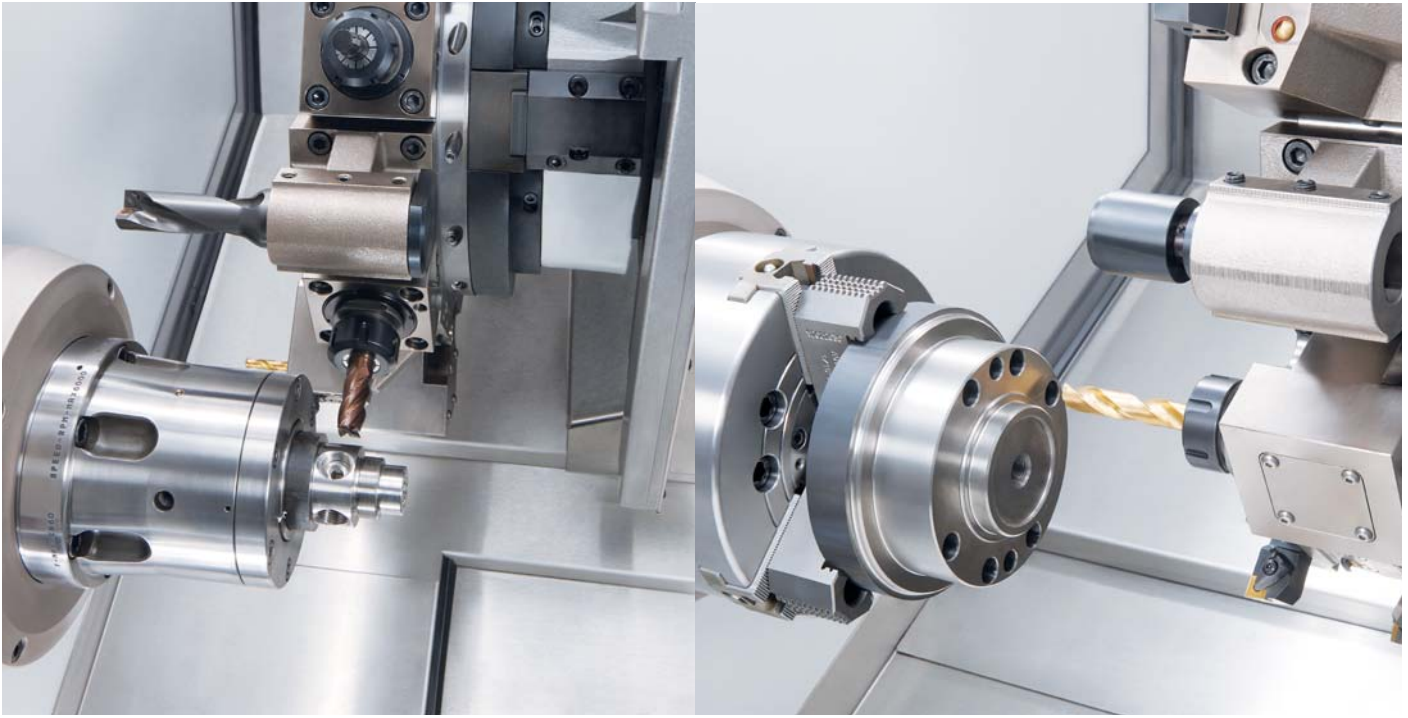

**ROTARY TOOLS, C-AXIS, Y-AXIS AND SUB-SPINDLE:
complete machining in one set-up**



Operations performed with the Y-axis

- 1 Flat milling in repeated cuts
 - 2 Irregular slot milling (roughness-finishing)
 - 3 Key-way milling
 - 4 Thread milling
 - 5 Drilling and milling grid holes
- The operations 2-3-4-5 can be performed with axial tools also on the surface of the workpiece.



POLYGON TURNING

This optional feature allows to turn polygons and threads provided the suitable driven tools are used. The gear hobbing tool allows machining of gears.



SUB-SPINDLE WITH C-AXIS: complete machining in one set-up

SPINDLE SYNCHRONISATION
SUB-SPINDLE
LOAD MONITORING WHEN THE WORKPIECE
IS TRANSFERRED FROM THE MAIN
TO THE SUB-SPINDLE

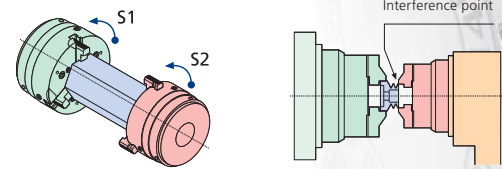

SIMULTANEOUS MACHINING

Thanks to this option, two tools can work
simultaneously on both spindles.
Cycle time is drastically reduced.

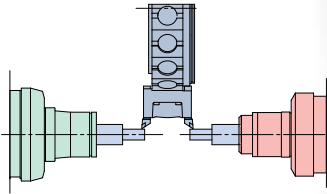

Turn operations on the sub-spindle with the static toolholders



Machining on the sub-spindle with the rotary tools and C-axis



Increased productivity

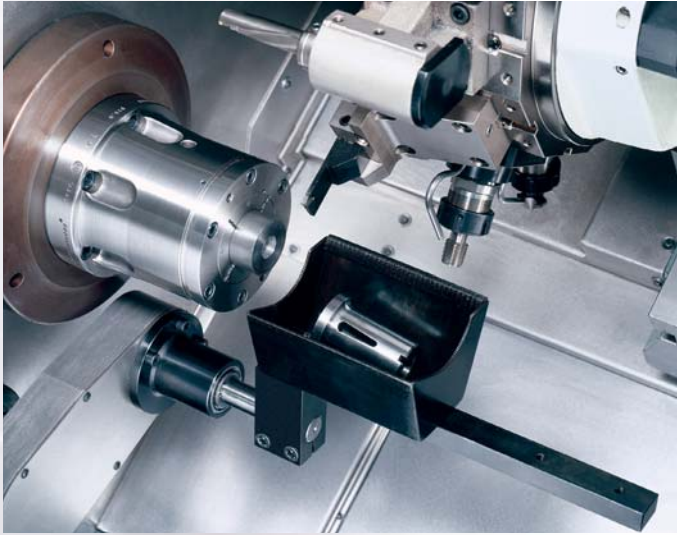

PARTS-CATCHER

Two styles of automatic parts-catcher systems are available on the B620:

- 1) The common parts-catcher arm system with parts bucket that allows the unloading of finished parts on to a parts conveyor. (unloading from the main and the sub-spindle)
- 2) The new parts-catcher arm system that takes the finished part from the sub-spindle and unloads it directly on to a secondary parts conveyor (unloading through the sub-spindle only).

Unloading sequence of the parts-catcher arm on the sub-spindle:

- Pick-up of finished part
- Unloading on to the primary parts conveyor
- Collection of finished part on to the secondary parts conveyor

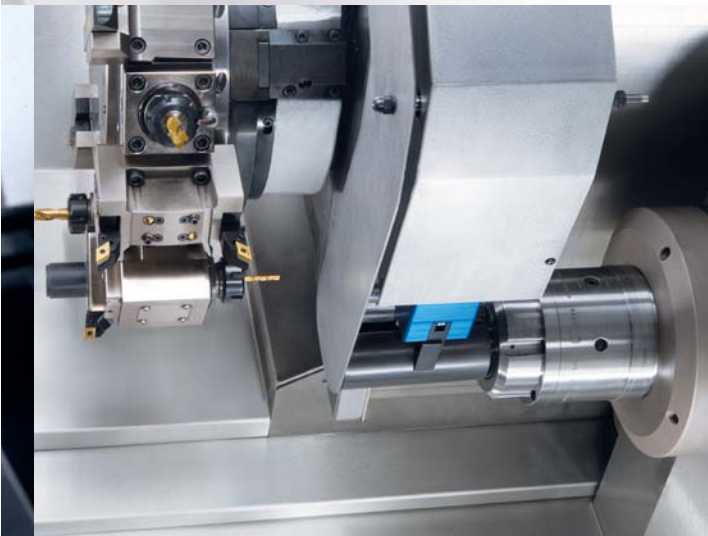

PARTS-CATCHER
ON SUB-SPINDLE SIDE

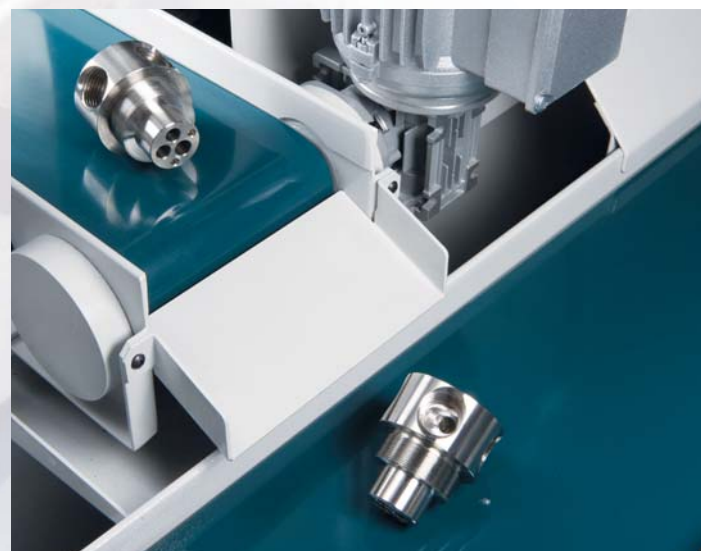

TURNING FIELD/MILLING FIELD
TOWARDS MAIN SPINDLE

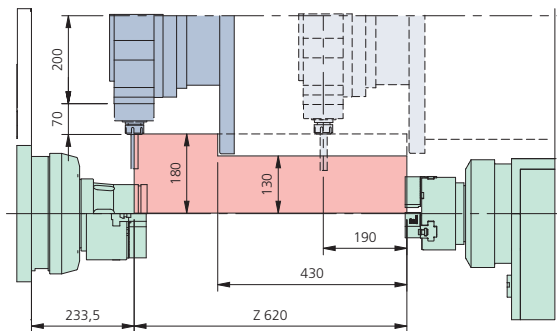
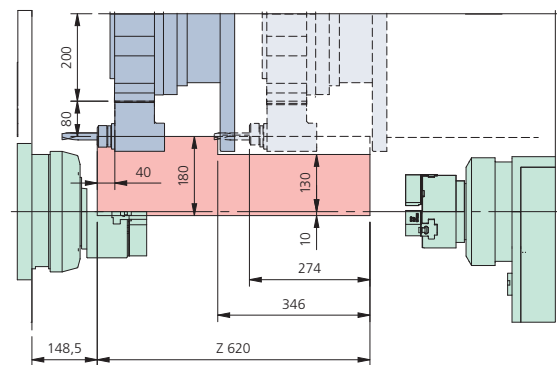
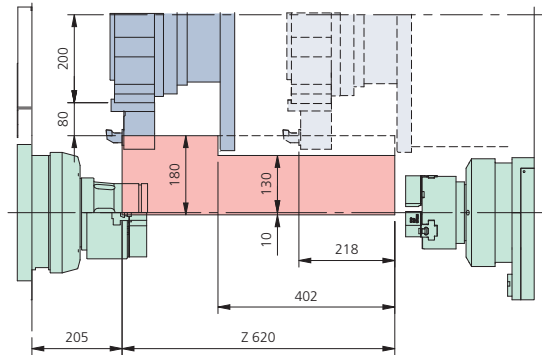
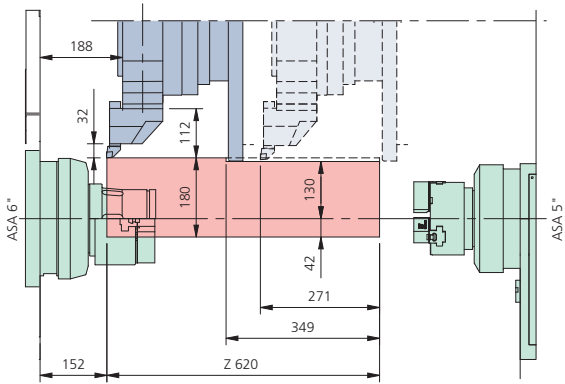

TURNING FIELD/MILLING FIELD
TOWARDS SUB-SPINDLE

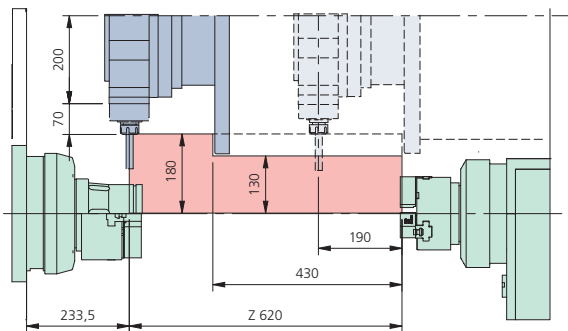
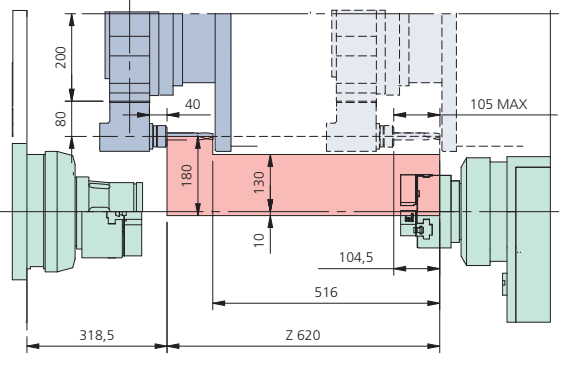
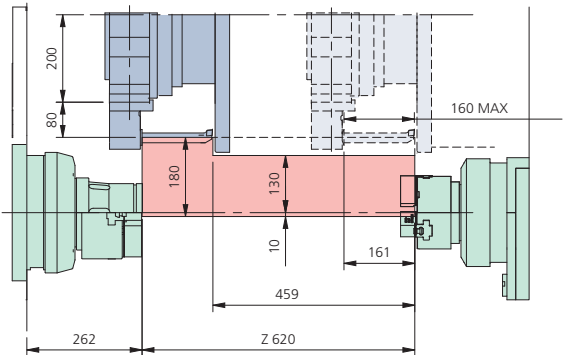
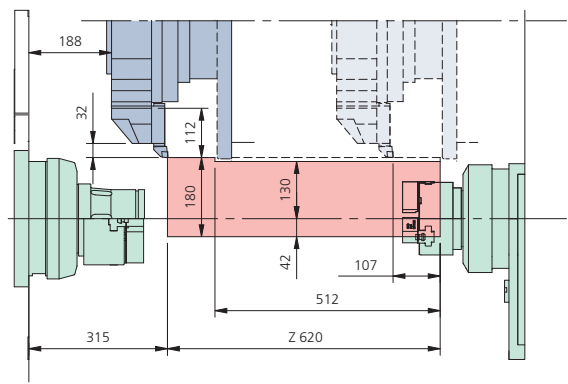

1

1

1

FRONT SIDE MAIN AND SUB-SPINDLE

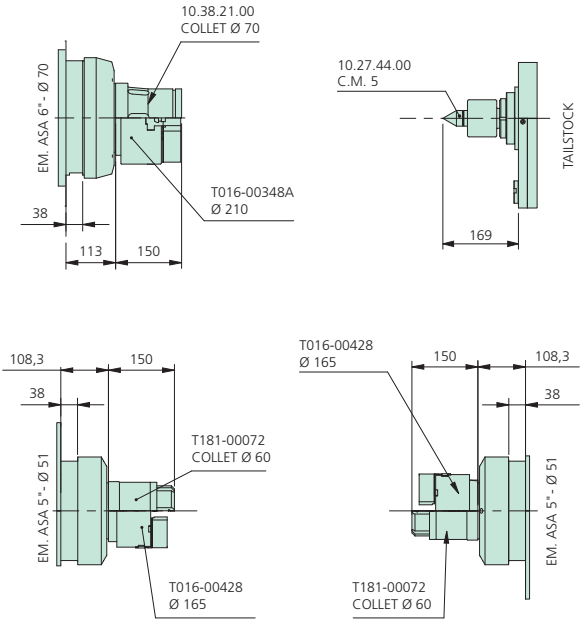

AXES TRAVELS

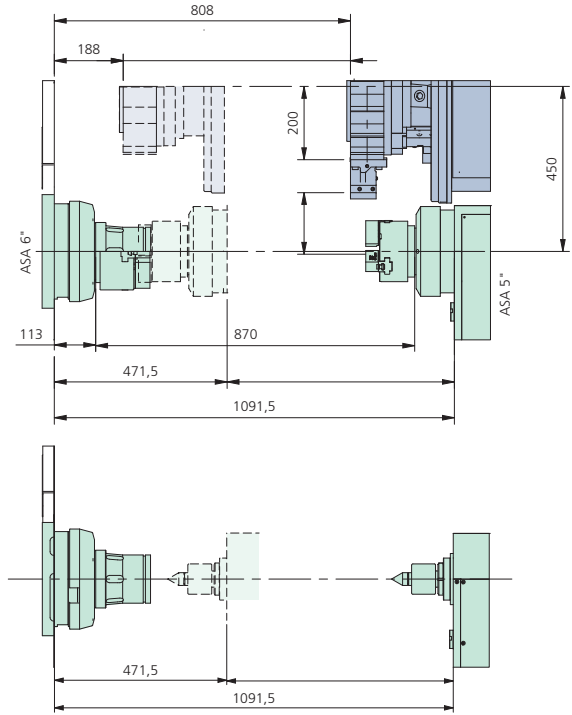

15-POST TURRET CAPABILITY

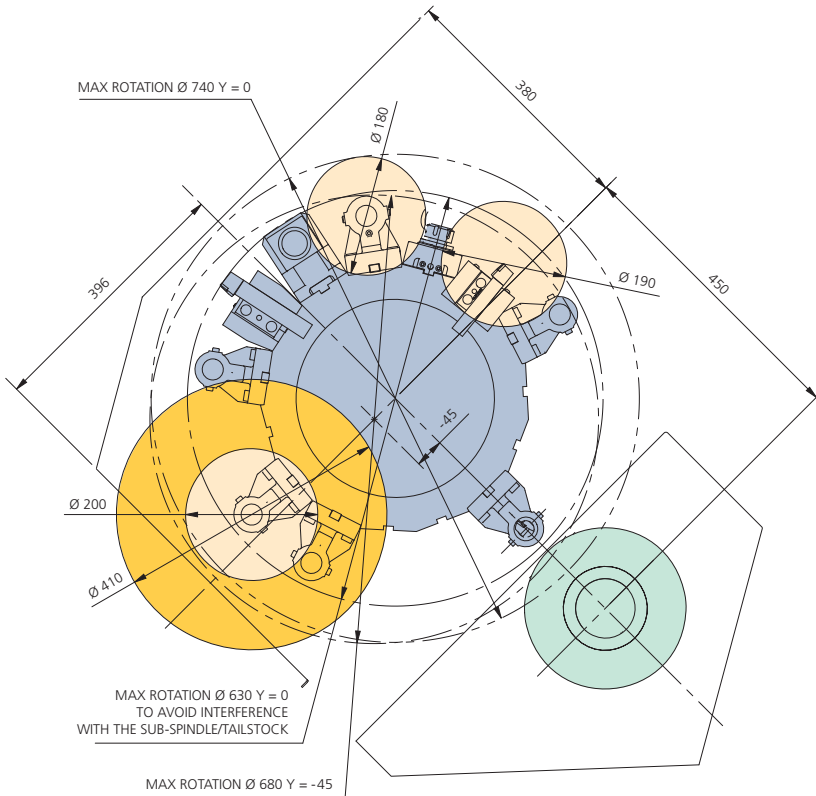

Y-AXIS FIELD

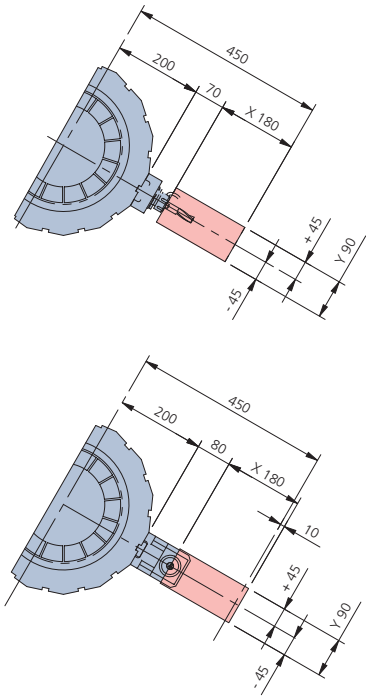

MT drill
 Tapered reduction bush MT
 1= 41.14.01.09
 2= 41.14.01.08
 3= 41.14.01.07

Tap
 Collet ER 20
 41.34.02.XX
 Ø min. 2 mm
 Ø max 13 mm

Twist drill
 Topping collets ER 20
 T170 - 00XXX
 M 4 min.
 M 12 max

Inner turning tool

U-drill
 Drill

Tap
 Topping collets ER 25
 T170 - 00XXX
 M 4 min.
 M 16 max

Reduction bush
 41.14.10.01 - Ø 12
 41.14.10.02 - Ø 16
 41.14.10.03 - Ø 20
 41.14.10.04 - Ø 25

Collet holder ER 20
 41.34.02.00

Topping collets ER 20
 T170 - 00XXX
 M 4 min.
 M 12 max

Collet holder ER 20
 41.34.02.00

Bar-stopper
 41.07.02.10

Reduction bush
 41.14.10.01 - Ø 12
 41.14.10.02 - Ø 16
 41.14.10.03 - Ø 20
 41.14.10.04 - Ø 25

Collet holder
 T181-00020

Inner turning tool

Drill

Tap

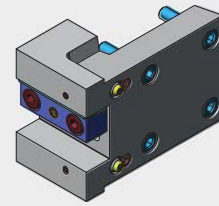

Radial short-style toolholder 20x20 10.88.02.00
 Radial short-style toolholder 25x25 41.03.37.00

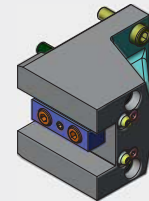

Tool holder 20x20 10.57.60.00
 Tool holder 25x25 10.88.16.00

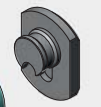

Coolant plug 10.57.75.03

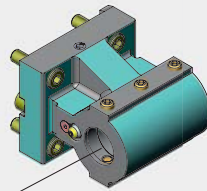

Boring bar holder Ø32 10.57.75.00

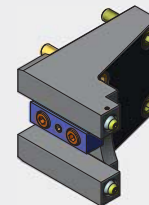

Cut-off tool holder 20x20 10.57.77.00
 Cut-off tool holder 25x25 0088-00047

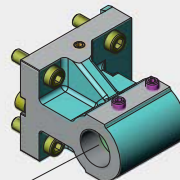

Retractable boring bar holder Ø32 10.57.74.00

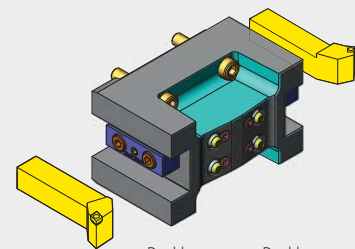

Double tool-holder 20x20 10.57.76.00
 Double tool-holder 25x25 10.88.10.00

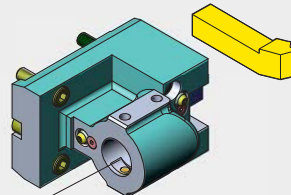

Boring bar holder Ø32 and tool-holder 20x20 10.57.91.00

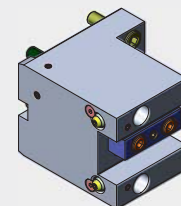

Frontal tool-holder 20x20 41.03.19.00
 Frontal tool-holder 25x25 41.03.36.00

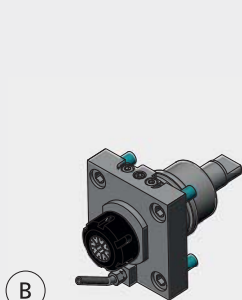

B
Short-style radial driven tool
T314-00049 ER25



Radial live-spindle
10.57.88.00 ER25
T134-00061 ER32
● T134-00071 ER32
■ T134-00089A ER32

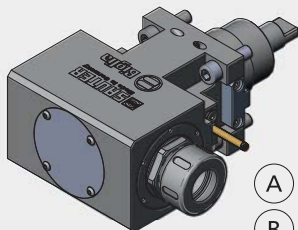

A
Axial live-spindle
T134-00212 ER25
T134-00210 ER32
● T134-00213 ER25
● T134-00211 ER32

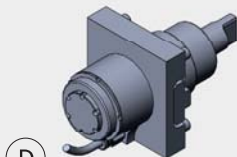

D
Driven tool 12000 rpm/min
H=70 T134-00060

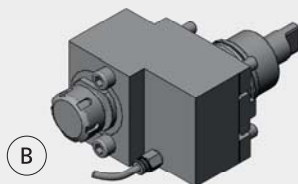

B
Radial live-spindle
8000 rpm
H=108 T134-00026

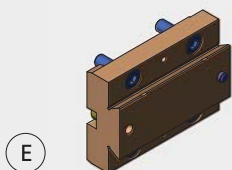

E
Base for multiple-holder
10.57.92.00

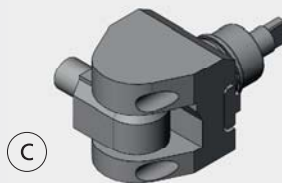

C
Adjustable live-spindle
3000 rpm
T134-00057

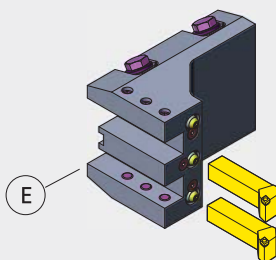

E
Vertical double tool-holder
41.03.25.00

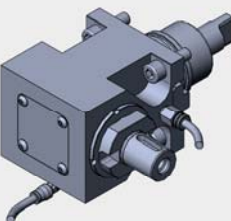

Polygon live-spindle
42.47.10.43

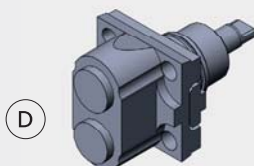

D
* Radial live spindle, double
8000 rpm
41.32.30.00

- * Only for Y-YS
- With internal coolant
- With stronger bearings

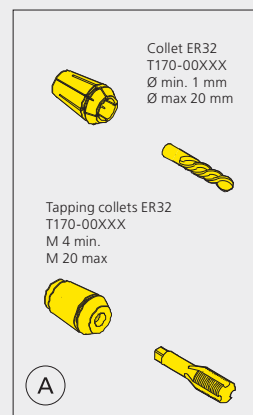

Collet ER32
T170-00XXX
Ø min. 1 mm
Ø max 20 mm

Tapping collets ER32
T170-00XXX
M 4 min.
M 20 max

A

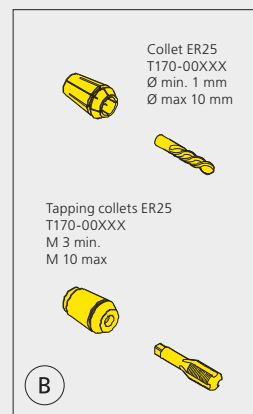

Collet ER25
T170-00XXX
Ø min. 1 mm
Ø max 10 mm

Tapping collets ER25
T170-00XXX
M 3 min.
M 10 max

B

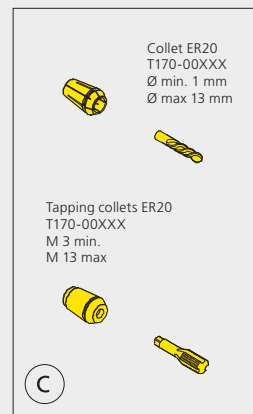

Collet ER20
T170-00XXX
Ø min. 1 mm
Ø max 13 mm

Tapping collets ER20
T170-00XXX
M 3 min.
M 13 max

C

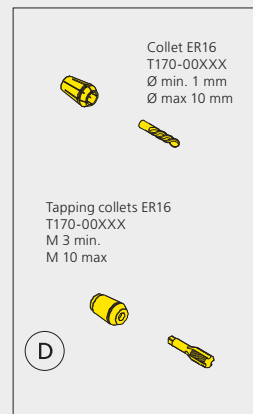

Collet ER16
T170-00XXX
Ø min. 1 mm
Ø max 10 mm

Tapping collets ER16
T170-00XXX
M 3 min.
M 10 max

D

New Fanuc i-HMI



ERGONOMIC OPERATOR PANEL

- CNC FANUC i-HMI:
- 15" colour display touch screen
- QWERTY keyboard
- BIGLIA operator panel
- Data transmission: Ethernet gate, memory card, USB, RS232 port



INTUITIVE AND EXTREMELY USER-FRIENDLY

The i-HMI is the new human-machine interface, 15" colour display with touch screen. The brand-new i-HMI system offers a high performance operating area where a simple touch allows the operator to gain access to all CNC functions: from work planning to BIGLIA customised pages, real time display of machining conditions and records of specific technical documentation.



DATA DISPLAY

Data displayed while machining includes: actual position of axes, machining feedrates, information on the spindle speed and current absorption, modal G-codes and machining cycle: all this on one screen page and in real time.



MANUAL GUIDE: QUICK AND EASY FOR PROGRAM RELIABILITY

The innovative MANUAL GUIDE software package provides operators with access to a very simple and user-friendly graphics interface, strong "editing" functions and offers a wide selection of machining cycles (turning, milling and drilling). This system allows the execution of even the most complex programs with ease of operation. The 3D simulation facilitates the checking of programmes before machining operations (option).

Biglia customised interface for a more intuitive process



NEW OPERATOR PANEL

Using a simple touch, the new panel allows the operator to select, enable and disable all main functions during set-up operations. The green and red colours facilitate an immediate and fast reaction which results in reduced set-up times and cost saving.



QUICK DATA VIEW

This option can be used with digital documentation in the appropriate folder. Tailstock set-up, BIGLIA customised tool life management, SBS tool load monitoring system, CSS spindle rpm variation – all in a simple and interactive mode.



ANGULAR DISPLACEMENT

For machines equipped with a sub-spindle this enables fast auto setting of the angular displacement for machining polygon bars.

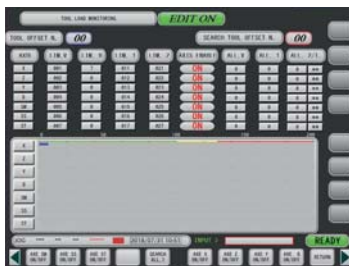

SBS: TOOL LOAD MONITORING (Option)

This system monitors the loading of the most heavily used tools such as cutting tools, roughening tools, drills or U-drills. It ensures safe automatic machining with limited operator presence (option).



CSS: SPINDLE RPM VARIATION (Option)

This option allows you to change the spindle rpm to eliminate resonance and vibration problems during embossing machining of parts.



USER-FRIENDLY – EASY TO SET-UP

Easy dialogue and set-up in connection with all the main machine features such as the parts-catcher with basculating arm, the B-axis tailstock and the tailstock to drill.



Management, Maintenance and Diagnostics, Industry 4.0

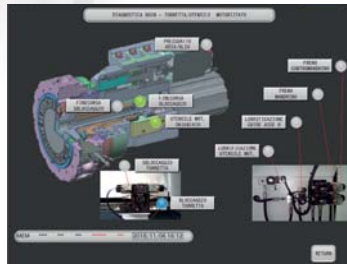

MANAGEMENT, DIAGNOSTICS and MAINTENANCE

Constant and fast monitoring of the main data related to maintenance and machining conditions of the main machine components. Monitor operating pressures, motors, wears and oil levels along with simple instructions on how and where to troubleshoot.



PRODUCTION MANAGEMENT INDUSTRY 4.0 (Option)

Iprod is the brand-new MES System for production management developed for the small to medium-sized manufacturer, completely based on the IoT data provided by the CNC unit. Iprod is the right solution for the Industry 4.0 to improve productivity and efficiency thanks to the IoT applications:

- Complete order processing (without ERP system)
- Planning of production
- Planning of work shifts
- Advanced report
- Preventive maintenance
- Integration with ERP (if already in the factory)
- Monitoring energy consumption

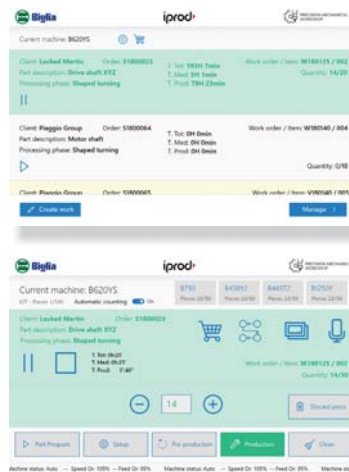

T E C H N I C A L S P E C I F I C A T I O N S

B620

MACHINE TYPE		B620 ASA 5"	B620 ASA 6"
MACHINING CAPACITY			
Bar capacity	mm	51	70
Max. machining diameter	mm	250	360
Max. machining length	mm	620	
Max. swing over diameter	mm	700	
MAIN SPINDLE			
Max. speed	rpm	5000	4500
Spindle nose	ASA	5"	6"
Spindle bore	mm	59,5	77,5
Inside diam. of bearings	mm	90	110
Chuck diameter	mm	165 / 210	210 / 250
Motor power	kW	17 - 25	30 - 40
Max. torque	Nm	108 - 159	286
SUB-SPINDLE			
Max. speed	rpm	5000	
Spindle nose	ASA	5"	
Spindle bore	mm	59,5	
Drawtube inside diameter	mm	50	
Inside diam. of bearings	mm	90	
Chuck diameter	mm	140 / 165	
Motor power	kW	17 - 25	
Max. torque	Nm	108 - 159	
TURRET			
No of tools	N°	15	
Tool shank for OD / ID turning	mm	20x20 - 25x25 - Ø32	
Turret indexing (1 pos)	sec	0,15	
LIVE TOOLING			
No of live tools	N°	15	
Max. speed	rpm	6000	
Motor power	kW	11 - 13	
Max. torque	Nm	27 - 38	
C-AXIS			
Min. programmable value	°	0,001	
Max. rapid traverse	rpm	100	
ASSI			
X-axis stroke	mm	180	
Z-axis stroke	mm	620	
Y-axis stroke	mm	+45 / -45	
B-axis stroke	mm	620	
X-axis rapid traverse	m/min	18	
Z-axis rapid traverse	m/min	30	
Y-axis rapid traverse	m/min	18	
B-axis rapid traverse	m/min	30	
TAILSTOCK			
Morse taper	MT	5 and 4	
B-axis rapid traverse	m/min	18	
COOLING SYSTEM			
Tank capacity	l	300	
Pump nominal displacement	l/min	60	
Electropump motor rating	kW	1,1	
DIMENSIONS AND WEIGHT			
Machine with swarf conveyor	cm	455,1x206,5x204,2h	
Spindle centre height	mm	1080	
Machine weight with swarf conv.	kg	6500	6650

CNC-TURNING CENTRES

© Designed by **accentus**

MACHINE OVERALL DIMENSIONS

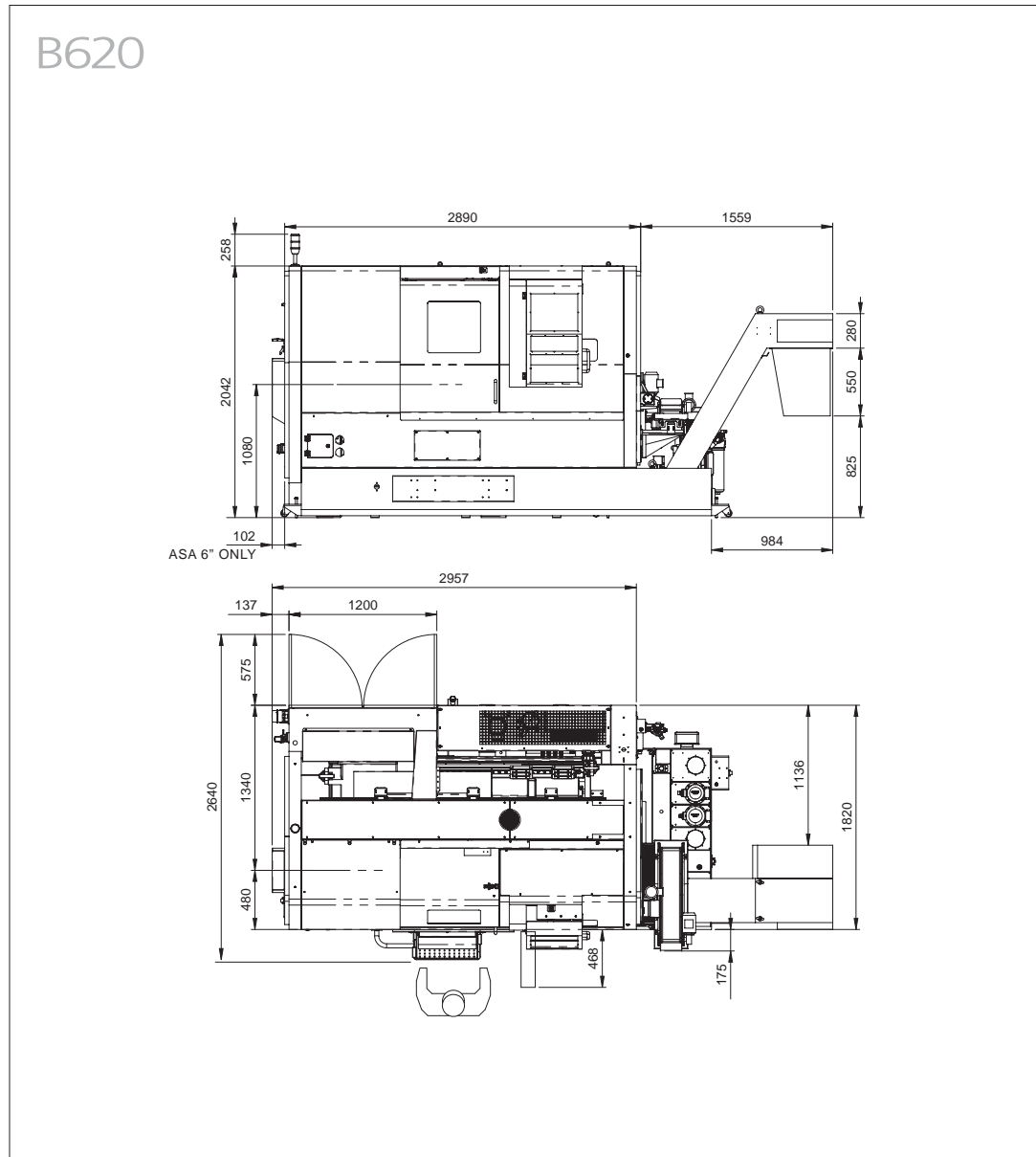

OFFICINE E. BIGLIA & C. SPA • I-14045 INCISA SCAPACCINO (AT)
Tel.: +39 0141 7831 • Fax: +39 0141 783327 • www.bigliaspa.it

A017-00102ING • 03/2019 THE SPECIFICATIONS CONTAINED HEREIN ARE NOT BINDING